



MULTI CHANNEL AV RECEIVER  
STR-DH750/STR-DH550



Use this Help Guide when you have any questions on how to use the receiver.

In this Help Guide, STR-DH750 is used for illustration purposes unless when otherwise indicated.

[Preparation](#)



[Enjoying Video and Sound](#)



[Using BLUETOOTH Features \(for STR-DH750 only\)](#)



[Using Other Features](#)



[Adjusting Settings](#)



[Parts and Controls](#)



[Announcements](#)



[Troubleshooting](#)



[Notes on use](#)

4-488-933-11(1)

Copyright 2014 Sony Corporation

# Table Of Contents

Preparation.....	1
Before using.....	11
Procedure to start using the receiver.....	51
Supplied accessories.....	52
Digital audio formats supported by the receiver.....	53
Notes on connecting cables.....	55
Using HDMI connections.....	56
Using MHL (Mobile High-Definition Link) connections.....	57
Installing and connecting speakers.....	12
Installing speakers.....	58
Connecting speakers.....	59
Connecting audio-visual devices and the antennas (aerials).....	13
Connecting a TV.....	61
Connecting devices with HDMI jacks.....	64
Connecting devices with jacks other than HDMI jacks.....	66
Connecting an iPhone, iPod, or USB device.....	68
Connecting an MHL-compatible mobile device.....	69
Connecting the antennas (aerials).....	70
Turning on the receiver/preparing the remote control.....	14
Setting the voltage selector.....	71
Inserting batteries into the remote control.....	72
Turning on the receiver.....	73
Initial setup of the receiver.....	15
Setting up the receiver using the Easy Setup.....	74
Enjoying Video and Sound.....	2
Basic operations.....	16
Using the menu on the TV screen.....	75
Enjoying video/sound from the connected device.....	76
Playing content from an iPhone/iPod.....	17
Compatible iPhone/iPod models.....	78
Notes on iPhone/iPod.....	79
Enjoying audio content stored on an iPhone/iPod via the USB port.....	80
Enjoying audio content stored on a BLUETOOTH device (for STR-DH750 only).....	81
Compatible iPhone/iPod models.....	78
Playing content from a USB device.....	18
Compatible USB devices and USB specifications.....	83
Notes on USB devices.....	85

Enjoying audio content stored on a USB device.....	86
Listening to the radio.....	19
Listening to FM/AM radio.....	87
Presetting FM/AM radio stations (Preset Memory).....	88
Tuning to a station directly (Direct Tuning).....	89
Changing the AM tuning scale (for USA and Canadian models only).....	90
Receiving RDS broadcasts (for European and Australian models only).....	91
Enjoying sound effects.....	20
Selecting a sound field (Sound Field).....	92
Resetting sound fields to the default settings.....	93
Notes on sound fields.....	94
Enjoying clear sound at a low volume level (Night Mode).....	95
Adjusting the equalizer (Equalizer).....	96
Selecting the Auto Calibration type (Calibration Type).....	97
Enjoying high-fidelity sound (Pure Direct).....	98
Using BLUETOOTH Features (for STR-DH750 only).....	3
Enjoying audio content stored on a BLUETOOTH device (for STR-DH750 only).....	21
Compatible BLUETOOTH version and profiles (for STR-DH750 only).....	99
Turning the BLUETOOTH function on/off (BT Power) (for STR-DH750 only).....	100
Enjoying audio content stored on a BLUETOOTH device with a one-touch connection (NFC) (for STR-DH750 only).....	101
Enjoying audio content stored on a BLUETOOTH device (for STR-DH750 only).....	81
Controlling a BLUETOOTH device using the remote control (for STR- DH750 only).....	102
Controlling the receiver using a smartphone or tablet device (SongPal) (for STR-DH750 only).....	22
Controlling the receiver using a smartphone or tablet device (SongPal) ( for STR-DH750 only).....	103
Using Other Features.....	4
Interlocking with BRAVIA TV and other devices (“BRAVIA” Sync) .....	23
What is “BRAVIA” Sync? .....	104
Preparing for “BRAVIA” Sync .....	105
Interlocking other devices using an HDMI connection (“BRAVIA” Sync) .....	106
Configuring video and sound settings.....	24
Enjoying sound of TV broadcasts from the receiver.....	107
Switching between digital and analog audio (Input Mode).....	108
Using other video/audio input jacks (Audio Input Assign).....	109

Configuring speaker settings.....	25
Adjusting the sound balance automatically (Auto Calibration).....	110
Using bi-amplifier connections (for STR-DH750 only).....	111
Using the sleep timer.....	26
Using the sleep timer.....	112
Checking information on the receiver.....	27
Viewing information on the display panel.....	113
Adjusting Settings.....	5
Easy Setup.....	28
Setting up the receiver using the Easy Setup.....	74
Speaker Settings.....	29
Performing Auto Calibration.....	114
Selecting the Auto Calibration type (Calibration Type).....	97
Selecting the speaker pattern (Speaker Pattern).....	116
Setting the assignment for the speaker terminals (SB Assign) (for STR-	
DH750 only).....	117
Adjusting the speaker level (Manual Setup).....	118
Adjusting the speaker size (Manual Setup).....	119
Adjusting the speaker distance (Manual Setup).....	120
Setting the crossover frequency of the speakers (Crossover Freq.).....	121
Outputting a test tone from each speaker (Test Tone).....	122
Selecting the unit of measurement (Distance Unit).....	123
Audio Settings.....	30
Enjoying clear sound at a low volume level (Night Mode).....	95
Adjusting the equalizer (Equalizer).....	96
Selecting a sound field (Sound Field).....	92
Synchronizing audio with video output (A/V Sync.).....	124
Adjusting the volume automatically (Auto Volume).....	125
Selecting the language of digital broadcasts (Dual Mono).....	126
Compressing the dynamic range (D.Range Comp.).....	127
HDMI Settings.....	31
Controlling HDMI devices (Control for HDMI).....	128
Passing HDMI signals through (Pass Through).....	129
Setting the HDMI audio signal output of connected devices (HDMI Audio	
Out).....	130
Setting the level of the subwoofer (Subwoofer Level).....	131
Speeding up the display when switching the HDMI input (Fast View).....	132
Automatically switching the input when an MHL device is played (MHL	
Auto Input).....	133
Input Settings.....	32

Changing the assignment and display for the input jacks.....	134
Changing the name for each input (Name In).....	135
System Settings.....	33
Selecting the language (Language).....	136
Setting standby mode (Auto Standby).....	137
Using the menu on the display panel.....	34
Operating the receiver with the menu on the display panel.....	138
Viewing information on the display panel.....	113
Reverting to the factory default settings.....	35
Parts and Controls.....	6
Receiver.....	36
Front panel (STR-DH750).....	140
Front panel (STR-DH550).....	142
Rear panel (STR-DH750).....	144
Rear panel (STR-DH550).....	145
Indicators on the display panel.....	146
Remote control.....	37
Remote control.....	148
Announcements.....	7
Specifications.....	38
Specifications.....	150
Supplied accessories.....	52
Trademarks.....	39
Trademarks.....	155
Troubleshooting.....	8
Error messages.....	40
PROTECTOR.....	157
USB FAIL.....	158
List of messages after Auto Calibration measurements.....	159
iPhone/iPod message list.....	160
USB message list.....	161
Power.....	41
The receiver is turned off automatically.....	162
Image.....	42
No image appears on the TV.....	163
No 3D image appears on the TV.....	164
No 4K image appears on the TV.....	165
No image is output from the TV when the receiver is in standby mode.....	166
The OSD menu does not appear on the TV screen.....	167
The display panel is turned off.....	168

Sound.....	43
No sound or only a very low level of sound is heard, no matter which device is selected.....	169
There is severe humming or noise.....	170
No sound or only a very low level of sound is heard from specific speakers.....	171
There is no sound from a specific device.....	172
The left and right sound is unbalanced or reversed.....	174
Dolby Digital or DTS multi-channel sound is not reproduced.....	175
The surround effect cannot be obtained.....	176
A test tone is not output from the speakers.....	177
A test tone is output from a different speaker than the speaker displayed on the TV screen.....	178
No sound is output from the TV when the receiver is in standby mode.....	179
Tuner.....	44
The FM reception is poor.....	180
The FM stereo reception is poor.....	181
You cannot tune to radio stations.....	182
RDS does not work (for European and Australian models only).....	183
The RDS information that you want does not appear (for European and Australian models only).....	184
iPhone/iPod.....	45
The sound is distorted.....	185
There is no sound from an iPhone/iPod.....	186
An iPhone/iPod cannot be charged.....	187
An iPhone/iPod cannot be operated.....	188
The ringtone volume of an iPhone does not change.....	189
USB devices.....	46
Are you using a compatible USB device?.....	190
There is noise, skipping, or distorted sound.....	191
A USB device is not recognized.....	192
Playback does not start.....	193
A USB device cannot be connected to the USB port.....	194
Erroneous display.....	195
[Reading] is displayed for an extended time, or it takes a long time before playback starts.....	196
An audio file cannot be played.....	197
BLUETOOTH devices (for STR-DH750 only).....	47
Pairing cannot be done (for STR-DH750 only).....	198
Cannot make a BLUETOOTH connection (for STR-DH750 only).....	199

The sound skips or fluctuates, or the connection is lost (for STR-DH750 only).....	200
The sound of your BLUETOOTH device cannot be heard on the receiver (for STR-DH750 only).....	201
Severe humming or noise (for STR-DH750 only).....	202
SongPal application is closed (for STR-DH750 only).....	203
“BRAVIA” Sync (Control for HDMI) .....	48
The Control for HDMI function does not work.....	204
The Audio Return Channel (ARC) function does not work.....	205
An MHL-compatible source device cannot be charged.....	206
No image from an MHL-compatible source device.....	207
Remote control.....	49
The remote control does not function.....	208
If the problem is not solved.....	50
Reverting to the factory default settings.....	139
Resetting sound fields to the default settings.....	93
Customer support websites.....	209
Notes on use.....	9



MULTI CHANNEL AV RECEIVER  
STR-DH750/STR-DH550

Preparation

---

[Before using](#)



[Installing and connecting speakers](#)



[Connecting audio-visual devices and the antennas \(aerials\)](#)



[Turning on the receiver/preparing the remote control](#)



[Initial setup of the receiver](#)



[Notes on use](#)

4-488-933-11(1)

Copyright 2014 Sony Corporation





MULTI CHANNEL AV RECEIVER  
STR-DH750/STR-DH550

Enjoying Video and Sound

---

[Basic operations](#)



[Playing content from an iPhone/iPod](#)



[Playing content from a USB device](#)



[Listening to the radio](#)



[Enjoying sound effects](#)



---

[Notes on use](#)

4-488-933-11(1)

Copyright 2014 Sony Corporation



MULTI CHANNEL AV RECEIVER  
STR-DH750/STR-DH550

Using BLUETOOTH Features (for STR-DH750 only)

---

[Enjoying audio content stored on a BLUETOOTH device \(for STR-DH750 only\)](#)



[Controlling the receiver using a smartphone or tablet device \(SongPal\) \(for STR-DH750 only\)](#)

---



[Notes on use](#)

4-488-933-11(1)

Copyright 2014 Sony Corporation



MULTI CHANNEL AV RECEIVER  
STR-DH750/STR-DH550

Using Other Features

---

[Interlocking with BRAVIA TV and other devices \("BRAVIA" Sync\)](#)



---

[Configuring video and sound settings](#)



---

[Configuring speaker settings](#)



---

[Using the sleep timer](#)



---

[Checking information on the receiver](#)



---

[Notes on use](#)

4-488-933-11(1)

Copyright 2014 Sony Corporation



MULTI CHANNEL AV RECEIVER  
STR-DH750/STR-DH550

Adjusting Settings

---

[Easy Setup](#)



[Speaker Settings](#)



[Audio Settings](#)



[HDMI Settings](#)



[Input Settings](#)



[System Settings](#)



[Using the menu on the display panel](#)



[Reverting to the factory default settings](#)



[Notes on use](#)

4-488-933-11(1)

Copyright 2014 Sony Corporation



MULTI CHANNEL AV RECEIVER  
STR-DH750/STR-DH550

Parts and Controls

---

[Receiver](#)



[Remote control](#)



[Notes on use](#)

4-488-933-11(1)

Copyright 2014 Sony Corporation



MULTI CHANNEL AV RECEIVER  
STR-DH750/STR-DH550

Announcements

---

[Specifications](#)



[Trademarks](#)



[Notes on use](#)

4-488-933-11(1)

Copyright 2014 Sony Corporation



MULTI CHANNEL AV RECEIVER  
STR-DH750/STR-DH550

Troubleshooting

---

[Error messages](#)

---



[Power](#)

---



[Image](#)

---



[Sound](#)

---



[Tuner](#)

---



[iPhone/iPod](#)

---



[USB devices](#)

---



[BLUETOOTH devices \(for STR-DH750 only\)](#)

---



[“BRAVIA” Sync \(Control for HDMI\)](#)

---



[Remote control](#)

---



[If the problem is not solved](#)

---



[Notes on use](#)

4-488-933-11(1)

Copyright 2014 Sony Corporation



MULTI CHANNEL AV RECEIVER  
STR-DH750/STR-DH550

Notes on use

June 2013

## Before use

To make full use of this content, please read the following notes thoroughly. Please note that they are subject to change without prior notice.

## Recommended system environment

The following system environments are recommended for displaying this content. You may not be able to view the content on other system environments.

### For viewing on a computer

Recommended browser

- With Microsoft Windows
  - Microsoft Internet Explorer 8 or later
  - Mozilla Firefox: latest version
  - Google Chrome™ : latest version
- With Apple Mac OS
  - Apple Safari Ver. 5 or later
  - Mozilla Firefox: latest version
  - Google Chrome : latest version

### For viewing on a smartphone or tablet

Basic operation has been confirmed on the standard browser for the noted devices running the following operating systems.

- Android™ 2.3 or later: Xperia series, Walkman running Android
- iOS 4 or later: iPhone, iPod touch, iPad

### JavaScript

JavaScript is used with this content for viewing convenience. If JavaScript is disabled in your web browser settings, the content may not operate properly or it may not be displayed correctly.

### Style Sheets

Cascading Style Sheets are used in designing this content. Page layout may not be as intended if you view the content with style sheets disabled or on a web browser that is not compatible with style sheets. However, operation will not be affected.

### Cookies

This content uses cookies. To use services incorporating cookies, you need to set your browser to allow cookies.



## Handling of personal information obtained from websites

Sony may use cookies, web beacons or similar technologies to make statistical analysis of customers' usage of this content while preserving anonymity.

### [Notes on use](#)

4-488-933-11(1)

Copyright 2014 Sony Corporation



MULTI CHANNEL AV RECEIVER  
STR-DH750/STR-DH550

Before using

---

[Procedure to start using the receiver](#)



---

[Supplied accessories](#)



---

[Digital audio formats supported by the receiver](#)



---

[Notes on connecting cables](#)



---

[Using HDMI connections](#)



---

[Using MHL \(Mobile High-Definition Link\) connections](#)



---

[Notes on use](#)

4-488-933-11(1)

Copyright 2014 Sony Corporation



MULTI CHANNEL AV RECEIVER  
STR-DH750/STR-DH550

Installing and connecting speakers

---

[Installing speakers](#)



[Connecting speakers](#)



[Notes on use](#)

4-488-933-11(1)

Copyright 2014 Sony Corporation



MULTI CHANNEL AV RECEIVER  
STR-DH750/STR-DH550

Connecting audio-visual devices and the antennas (aerials)

---

[Connecting a TV](#)



[Connecting devices with HDMI jacks](#)



[Connecting devices with jacks other than HDMI jacks](#)



[Connecting an iPhone, iPod, or USB device](#)



[Connecting an MHL-compatible mobile device](#)



[Connecting the antennas \(aerials\)](#)



---

[Notes on use](#)

4-488-933-11(1)

Copyright 2014 Sony Corporation



MULTI CHANNEL AV RECEIVER  
STR-DH750/STR-DH550

Turning on the receiver/preparing the remote control

---

[Setting the voltage selector](#)



---

[Inserting batteries into the remote control](#)



---

[Turning on the receiver](#)



---

[Notes on use](#)

4-488-933-11(1)

Copyright 2014 Sony Corporation



MULTI CHANNEL AV RECEIVER  
STR-DH750/STR-DH550

Initial setup of the receiver

---

[Setting up the receiver using the Easy Setup](#)



---

[Notes on use](#)

4-488-933-11(1)

Copyright 2014 Sony Corporation



MULTI CHANNEL AV RECEIVER  
STR-DH750/STR-DH550

Basic operations

---

[Using the menu on the TV screen](#)



[Enjoying video/sound from the connected device](#)



[Notes on use](#)

4-488-933-11(1)

Copyright 2014 Sony Corporation



MULTI CHANNEL AV RECEIVER  
STR-DH750/STR-DH550

Playing content from an iPhone/iPod

---

[Compatible iPhone/iPod models](#)



---

[Notes on iPhone/iPod](#)



---

[Enjoying audio content stored on an iPhone/iPod via the USB port](#)



---

[Enjoying audio content stored on a BLUETOOTH device \(for STR-DH750 only\)](#)



---

[Notes on use](#)

4-488-933-11(1)

Copyright 2014 Sony Corporation





MULTI CHANNEL AV RECEIVER  
STR-DH750/STR-DH550

Playing content from a USB device

---

[Compatible USB devices and USB specifications](#)



[Notes on USB devices](#)



[Enjoying audio content stored on a USB device](#)



---

[Notes on use](#)

4-488-933-11(1)

Copyright 2014 Sony Corporation



MULTI CHANNEL AV RECEIVER  
STR-DH750/STR-DH550

Listening to the radio

---

[Listening to FM/AM radio](#)



[Presetting FM/AM radio stations \(Preset Memory\)](#)



[Tuning to a station directly \(Direct Tuning\)](#)



[Changing the AM tuning scale \(for USA and Canadian models only\)](#)



[Receiving RDS broadcasts \(for European and Australian models only\)](#)



---

[Notes on use](#)

4-488-933-11(1)

Copyright 2014 Sony Corporation



MULTI CHANNEL AV RECEIVER  
STR-DH750/STR-DH550

Enjoying sound effects

---

Selecting a sound field (Sound Field)



---

Resetting sound fields to the default settings



---

Notes on sound fields



---

Enjoying clear sound at a low volume level (Night Mode)



---

Adjusting the equalizer (Equalizer)



---

Selecting the Auto Calibration type (Calibration Type)



---

Enjoying high-fidelity sound (Pure Direct)



---

Notes on use

4-488-933-11(1)

Copyright 2014 Sony Corporation



MULTI CHANNEL AV RECEIVER  
STR-DH750/STR-DH550

Enjoying audio content stored on a BLUETOOTH device (for STR-DH750 only)

---

[Compatible BLUETOOTH version and profiles \(for STR-DH750 only\)](#)

---



[Turning the BLUETOOTH function on/off \(BT Power\) \(for STR-DH750 only\)](#)

---



[Enjoying audio content stored on a BLUETOOTH device with a one-touch connection \(NFC\) \(for STR-DH750 only\)](#)

---



[Enjoying audio content stored on a BLUETOOTH device \(for STR-DH750 only\)](#)

---



[Controlling a BLUETOOTH device using the remote control \(for STR-DH750 only\)](#)

---



[Notes on use](#)

4-488-933-11(1)

Copyright 2014 Sony Corporation



MULTI CHANNEL AV RECEIVER  
STR-DH750/STR-DH550

Controlling the receiver using a smartphone or tablet device (SongPal) (for STR-DH750 only)

---

[Controlling the receiver using a smartphone or tablet device \(SongPal\) \(for STR-DH750 only\)](#)



---

[Notes on use](#)

4-488-933-11(1)

Copyright 2014 Sony Corporation



MULTI CHANNEL AV RECEIVER  
STR-DH750/STR-DH550

Interlocking with BRAVIA TV and other devices (“BRAVIA” Sync)

---

[What is “BRAVIA” Sync?](#)



[Preparing for “BRAVIA” Sync](#)



[Interlocking other devices using an HDMI connection \(“BRAVIA” Sync\)](#)



---

[Notes on use](#)

4-488-933-11(1)

Copyright 2014 Sony Corporation



MULTI CHANNEL AV RECEIVER  
STR-DH750/STR-DH550

Configuring video and sound settings

---

[Enjoying sound of TV broadcasts from the receiver](#)



[Switching between digital and analog audio \(Input Mode\)](#)



[Using other video/audio input jacks \(Audio Input Assign\)](#)



---

[Notes on use](#)

4-488-933-11(1)

Copyright 2014 Sony Corporation



MULTI CHANNEL AV RECEIVER  
STR-DH750/STR-DH550

Configuring speaker settings

---

[Adjusting the sound balance automatically \(Auto Calibration\)](#)



[Using bi-amplifier connections \(for STR-DH750 only\)](#)



---

[Notes on use](#)

4-488-933-11(1)

Copyright 2014 Sony Corporation





MULTI CHANNEL AV RECEIVER  
STR-DH750/STR-DH550

Using the sleep timer

---

[Using the sleep timer](#)



---

[Notes on use](#)

4-488-933-11(1)

Copyright 2014 Sony Corporation



MULTI CHANNEL AV RECEIVER  
STR-DH750/STR-DH550

Checking information on the receiver

---

[Viewing information on the display panel](#)

---



### Notes on use

4-488-933-11(1)

Copyright 2014 Sony Corporation



MULTI CHANNEL AV RECEIVER  
STR-DH750/STR-DH550

## Easy Setup

---

[Setting up the receiver using the Easy Setup](#)



### Notes on use

4-488-933-11(1)

Copyright 2014 Sony Corporation



MULTI CHANNEL AV RECEIVER  
STR-DH750/STR-DH550

## Speaker Settings

---

[Performing Auto Calibration](#)



[Selecting the Auto Calibration type \(Calibration Type\)](#)



[Selecting the speaker pattern \(Speaker Pattern\)](#)



[Setting the assignment for the speaker terminals \(SB Assign\) \(for STR-DH750 only\)](#)



[Adjusting the speaker level \(Manual Setup\)](#)



[Adjusting the speaker size \(Manual Setup\)](#)



[Adjusting the speaker distance \(Manual Setup\)](#)



[Setting the crossover frequency of the speakers \(Crossover Freq.\)](#)



[Outputting a test tone from each speaker \(Test Tone\)](#)



[Selecting the unit of measurement \(Distance Unit\)](#)



## Notes on use

4-488-933-11(1)

Copyright 2014 Sony Corporation



MULTI CHANNEL AV RECEIVER  
STR-DH750/STR-DH550

Audio Settings

---

Enjoying clear sound at a low volume level (Night Mode)



---

Adjusting the equalizer (Equalizer)



---

Selecting a sound field (Sound Field)



---

Synchronizing audio with video output (A/V Sync.)



---

Adjusting the volume automatically (Auto Volume)



---

Selecting the language of digital broadcasts (Dual Mono)



---

Compressing the dynamic range (D.Range Comp.)



---

Notes on use

4-488-933-11(1)

Copyright 2014 Sony Corporation



MULTI CHANNEL AV RECEIVER  
STR-DH750/STR-DH550

## HDMI Settings

---

[Controlling HDMI devices \(Control for HDMI\)](#)



[Passing HDMI signals through \(Pass Through\)](#)



[Setting the HDMI audio signal output of connected devices \(HDMI Audio Out\)](#)



[Setting the level of the subwoofer \(Subwoofer Level\)](#)



[Speeding up the display when switching the HDMI input \(Fast View\)](#)



[Automatically switching the input when an MHL device is played \(MHL Auto Input\)](#)



---

### Notes on use

4-488-933-11(1)

Copyright 2014 Sony Corporation



MULTI CHANNEL AV RECEIVER  
STR-DH750/STR-DH550

## Input Settings

---

[Changing the assignment and display for the input jacks](#)



[Changing the name for each input \(Name In\)](#)



## Notes on use

4-488-933-11(1)

Copyright 2014 Sony Corporation



MULTI CHANNEL AV RECEIVER  
STR-DH750/STR-DH550

System Settings

---

Selecting the language (Language)



Setting standby mode (Auto Standby)



---

Notes on use

4-488-933-11(1)

Copyright 2014 Sony Corporation





MULTI CHANNEL AV RECEIVER  
STR-DH750/STR-DH550

Using the menu on the display panel

---

[Operating the receiver with the menu on the display panel](#)



[Viewing information on the display panel](#)



[Notes on use](#)

4-488-933-11(1)

Copyright 2014 Sony Corporation



MULTI CHANNEL AV RECEIVER  
STR-DH750/STR-DH550

Reverting to the factory default settings

---

[Reverting to the factory default settings](#)



---

[Notes on use](#)

4-488-933-11(1)

Copyright 2014 Sony Corporation



MULTI CHANNEL AV RECEIVER  
STR-DH750/STR-DH550

Receiver

---

[Front panel \(STR-DH750\)](#)



---

[Front panel \(STR-DH550\)](#)



---

[Rear panel \(STR-DH750\)](#)



---

[Rear panel \(STR-DH550\)](#)



---

[Indicators on the display panel](#)



---

[Notes on use](#)

4-488-933-11(1)

Copyright 2014 Sony Corporation



MULTI CHANNEL AV RECEIVER  
STR-DH750/STR-DH550

Remote control

---

[Remote control](#)



---

[Notes on use](#)

4-488-933-11(1)

Copyright 2014 Sony Corporation



MULTI CHANNEL AV RECEIVER  
STR-DH750/STR-DH550

Specifications

---

[Specifications](#)



[Supplied accessories](#)



[Notes on use](#)

4-488-933-11(1)

Copyright 2014 Sony Corporation



MULTI CHANNEL AV RECEIVER  
STR-DH750/STR-DH550

Trademarks

---

[Trademarks](#)



---

[Notes on use](#)

4-488-933-11(1)

Copyright 2014 Sony Corporation



MULTI CHANNEL AV RECEIVER  
STR-DH750/STR-DH550

Error messages

---

[PROTECTOR](#)



---

[USB FAIL](#)



---

[List of messages after Auto Calibration measurements](#)



---

[iPhone/iPod message list](#)



---

[USB message list](#)



---

[Notes on use](#)

4-488-933-11(1)

Copyright 2014 Sony Corporation



MULTI CHANNEL AV RECEIVER  
STR-DH750/STR-DH550

## Power

---

The receiver is turned off automatically.



### Notes on use

4-488-933-11(1)

Copyright 2014 Sony Corporation





MULTI CHANNEL AV RECEIVER  
STR-DH750/STR-DH550

## Image

---

No image appears on the TV.



No 3D image appears on the TV.



No 4K image appears on the TV.



No image is output from the TV when the receiver is in standby mode.



The OSD menu does not appear on the TV screen.



The display panel is turned off.



## Notes on use

4-488-933-11(1)

Copyright 2014 Sony Corporation



MULTI CHANNEL AV RECEIVER  
STR-DH750/STR-DH550

## Sound

No sound or only a very low level of sound is heard, no matter which device is selected.



There is severe humming or noise.



No sound or only a very low level of sound is heard from specific speakers.



There is no sound from a specific device.



The left and right sound is unbalanced or reversed.



Dolby Digital or DTS multi-channel sound is not reproduced.



The surround effect cannot be obtained.



A test tone is not output from the speakers.



A test tone is output from a different speaker than the speaker displayed on the TV screen.



No sound is output from the TV when the receiver is in standby mode.



## Notes on use

4-488-933-11(1)

Copyright 2014 Sony Corporation



MULTI CHANNEL AV RECEIVER  
STR-DH750/STR-DH550

Tuner

---

The FM reception is poor.



The FM stereo reception is poor.



You cannot tune to radio stations.



RDS does not work (for European and Australian models only).



The RDS information that you want does not appear (for European and Australian models only).



Notes on use

4-488-933-11(1)

Copyright 2014 Sony Corporation



MULTI CHANNEL AV RECEIVER  
STR-DH750/STR-DH550

iPhone/iPod

---

The sound is distorted.



---

There is no sound from an iPhone/iPod.



---

An iPhone/iPod cannot be charged.



---

An iPhone/iPod cannot be operated.



---

The ringtone volume of an iPhone does not change.



---

Notes on use

4-488-933-11(1)

Copyright 2014 Sony Corporation



MULTI CHANNEL AV RECEIVER  
STR-DH750/STR-DH550

USB devices

---

Are you using a compatible USB device?



There is noise, skipping, or distorted sound.



A USB device is not recognized.



Playback does not start.



A USB device cannot be connected to the USB port.



Erroneous display.



[Reading] is displayed for an extended time, or it takes a long time before playback starts.



An audio file cannot be played.



---

Notes on use

4-488-933-11(1)

Copyright 2014 Sony Corporation



MULTI CHANNEL AV RECEIVER  
STR-DH750/STR-DH550

BLUETOOTH devices (for STR-DH750 only)

---

Pairing cannot be done (for STR-DH750 only).



Cannot make a BLUETOOTH connection (for STR-DH750 only).



The sound skips or fluctuates, or the connection is lost (for STR-DH750 only).



The sound of your BLUETOOTH device cannot be heard on the receiver (for STR-DH750 only).



Severe humming or noise (for STR-DH750 only).



SongPal application is closed (for STR-DH750 only).



---

Notes on use

4-488-933-11(1)

Copyright 2014 Sony Corporation



MULTI CHANNEL AV RECEIVER  
STR-DH750/STR-DH550

“BRAVIA” Sync (Control for HDMI)

---

The Control for HDMI function does not work.



The Audio Return Channel (ARC) function does not work.



An MHL-compatible source device cannot be charged.



No image from an MHL-compatible source device.



---

Notes on use

4-488-933-11(1)

Copyright 2014 Sony Corporation



MULTI CHANNEL AV RECEIVER  
STR-DH750/STR-DH550

## Remote control

---

The remote control does not function.



### Notes on use

4-488-933-11(1)

Copyright 2014 Sony Corporation





MULTI CHANNEL AV RECEIVER  
STR-DH750/STR-DH550

If the problem is not solved

---

[Reverting to the factory default settings](#)

---



[Resetting sound fields to the default settings](#)

---



[Customer support websites](#)

---



[Notes on use](#)

4-488-933-11(1)

Copyright 2014 Sony Corporation



MULTI CHANNEL AV RECEIVER  
STR-DH750/STR-DH550

## Procedure to start using the receiver

---

See the following topics in this order to start using the receiver properly.

1. [Installing speakers](#)
2. [Connecting speakers](#)
3. [Connecting a TV](#)
4. [Connecting devices with HDMI jacks](#)
5. [Connecting devices with jacks other than HDMI jacks](#)
6. [Inserting batteries into the remote control](#)
7. [Turning on the receiver](#)
8. [Setting up the receiver using the Easy Setup](#)

### Hint

- The image quality depends on the connecting jack. We recommend that you connect your devices via an HDMI connection if they have HDMI jacks.

### Notes on use

4-488-933-11(1)

Copyright 2014 Sony Corporation



MULTI CHANNEL AV RECEIVER  
STR-DH750/STR-DH550

Supplied accessories

---

- Startup Guide (1)
- Reference Guide (1)
- Remote control (1)
- R03 (size AAA) batteries (2)
- FM wire antenna (aerial) (1)



- AM loop antenna (aerial) (1)



- Optimizer microphone (1)



Notes on use

4-488-933-11(1)

Copyright 2014 Sony Corporation



MULTI CHANNEL AV RECEIVER  
STR-DH750/STR-DH550

## Digital audio formats supported by the receiver

---

The digital audio formats that this receiver can decode depend on the digital audio output jacks of the connected device. This receiver supports the following audio formats. The words in brackets are those indicated on the display panel.

### **Dolby Digital [DOLBY D]**

Maximum number of channels: 5.1

Connection with the receiver: COAXIAL/OPTICAL, HDMI (\*3)

### **Dolby Digital EX [DOLBY D EX] (for STR-DH750 only)**

Maximum number of channels: 6.1

Connection with the receiver: COAXIAL/OPTICAL, HDMI (\*3)

### **Dolby Digital Plus [DOLBY D +]**

Maximum number of channels: 7.1 (\*4)

Connection with the receiver: HDMI (\*3)

### **Dolby TrueHD [DOLBY HD] (\*1)**

Maximum number of channels: 7.1 (\*4)

Connection with the receiver: HDMI

### **DTS [DTS]**

Maximum number of channels: 5.1

Connection with the receiver: COAXIAL/OPTICAL, HDMI (\*3)

### **DTS-ES Discrete [DTS-ES DSC] (for STR-DH750 only)**

Maximum number of channels: 6.1

Connection with the receiver: COAXIAL/OPTICAL, HDMI (\*3)

### **DTS-ES Matrix [DTS-ES MTX] (for STR-DH750 only)**

Maximum number of channels: 6.1

Connection with the receiver: COAXIAL/OPTICAL, HDMI (\*3)

### **DTS 96/24 [DTS 96/24]**

Maximum number of channels: 5.1

Connection with the receiver: COAXIAL/OPTICAL, HDMI (\*3)

### **DTS-HD High Resolution Audio [DTS-HD HR] (\*1)**

Maximum number of channels: 7.1 (\*4)

Connection with the receiver: HDMI (\*3)

### **DTS-HD Master Audio [DTS-HD MA] (\*1, \*2)**

Maximum number of channels: 7.1 (\*4)

Connection with the receiver: HDMI

**DSD [DSD] (\*1) (for non-USA and Canadian models only)**

Maximum number of channels: 5.1

Connection with the receiver: HDMI

**Multi Channel Linear PCM [PCM] (\*1)**

Maximum number of channels: 7.1 (\*4)

Connection with the receiver: HDMI (\*3)

\*1 Audio signals are output in another format if the playback device does not correspond to the actual format. For details, refer to the operating instructions of the playback device.

\*2 Signals with a sampling frequency of more than 96 kHz are played at 96 kHz or 88.2 kHz.

\*3 These formats are compatible with MHL when you connect a MHL-compatible source device to the HDMI VIDEO IN (MHL) jack.

\*4 The signals will be output as 5.1 channel for STR-DH550.

[Notes on use](#)

4-488-933-11(1)

Copyright 2014 Sony Corporation



MULTI CHANNEL AV RECEIVER  
STR-DH750/STR-DH550

## Notes on connecting cables

---

- Be sure to disconnect the AC power cord (mains lead) before connecting cables.
- It is not necessary to connect all of the cables. Connect cables according to the availability of jacks on the connected device.
- Use a High Speed HDMI cable. 1080p, Deep Color (Deep Colour), 4K or 3D images may not be displayed properly if you use a Standard HDMI cable.
- We do not recommend using an HDMI-DVI conversion cable. If you connect an HDMI-DVI conversion cable to a DVI-D device, the sound and/or image may be lost. Connect separate audio cables or digital connecting cables, then reassign the input jacks if the sound is not output correctly. For details, see [“Using other video/audio input jacks \(Audio Input Assign\).”](#)
- When connecting optical digital cables, insert the plugs straight until they click into place.
- Do not bend or tie optical digital cables.

### Hint

- All of the digital audio jacks are compatible with 32 kHz, 44.1 kHz, 48 kHz, and 96 kHz sampling frequencies.

### **If you want to connect several digital devices, but cannot find an unused input**

See [“Using other video/audio input jacks \(Audio Input Assign\).”](#)

### Notes on use

4-488-933-11(1)

Copyright 2014 Sony Corporation



MULTI CHANNEL AV RECEIVER  
STR-DH750/STR-DH550

## Using HDMI connections

---

High-Definition Multimedia Interface (HDMI) is an interface that transmits video and audio signals in digital format. Connecting Sony “BRAVIA” Sync-compatible devices using HDMI cables simplifies operations. See [“Interlocking other devices using an HDMI connection \(“BRAVIA” Sync\).”](#)

### HDMI features

- Digital audio signals transmitted by HDMI can be output from the speakers connected to the receiver. This signal supports Dolby Digital, DTS, DSD (for non-USA and Canadian models only), and Linear PCM. For details, see [“Digital audio formats supported by the receiver.”](#)
- The receiver can receive Multi Channel Linear PCM (up to 8 channels) with a sampling frequency of 192 kHz or less via an HDMI connection.
- This receiver supports High Bitrate Audio (DTS-HD Master Audio, Dolby TrueHD), Deep Color (Deep Colour), “x.v.Color (x.v.Colour),” and 4K or 3D transmission.
- To enjoy 3D images, connect a 3D-compatible TV and video device (Blu-ray Disc player, Blu-ray Disc recorder, PlayStation 3, etc.) to the receiver using High Speed HDMI cables, put on 3D glasses, and then play 3D-compatible content.

#### Note

- Depending on the TV or video device, 4K or 3D images may not be displayed. Check the HDMI video formats supported by the receiver.
- Refer to the operating instructions of each connected device for details.

### Notes on use

4-488-933-11(1)

Copyright 2014 Sony Corporation



MULTI CHANNEL AV RECEIVER  
STR-DH750/STR-DH550

## Using MHL (Mobile High-Definition Link) connections

---

MHL (Mobile High-Definition Link) is an HD video and digital audio interface for connecting mobile phones and portable devices to HDTVs and other home entertainment products. MHL can support 1080p HD video and digital audio signals and supply power to the mobile device simultaneously. It also enables the remotes of TV and other home entertainment products to control the mobile phone and access its content.

### Note

- MHL-compatible mobile devices are charged when connected to the HDMI VIDEO IN (MHL) jack of the receiver while the receiver is turned on, or while the receiver is turned off when [Pass Through] is set to [On] (\*) or [Auto].

\* For USA, Canadian, and Australian models only

### Related Topic

- [Changing the name for each input \(Name In\)](#)

### Notes on use

4-488-933-11(1)

Copyright 2014 Sony Corporation





MULTI CHANNEL AV RECEIVER  
STR-DH750/STR-DH550

## Installing speakers

---

STR-DH750 allows you to use up to a 7.2-channel system (7 speakers and two subwoofers).

STR-DH550 allows you to use up to a 5.2-channel system (5 speakers and two subwoofers).

Typical examples of speaker system configurations are as follows.

### 5.1-channel speaker system

To fully enjoy theater-like multi-channel surround sound, you need five speakers (two front speakers, a center speaker, and two surround speakers) and a subwoofer.

### 7.1-channel speaker system using surround back speakers (for STR-DH750 only)

You can enjoy high-fidelity reproduction of recorded sound from a DVD or Blu-ray Disc in 6.1-channel or 7.1-channel format.

### 7.1-channel speaker system using front high speakers (for STR-DH750 only)

You can enjoy vertical sound effects by connecting an additional two front high speakers.

#### Note

- You cannot use the surround back speakers and the front high speakers simultaneously.

#### Related Topic

● [Connecting speakers](#)

#### Notes on use

4-488-933-11(1)

Copyright 2014 Sony Corporation



MULTI CHANNEL AV RECEIVER  
STR-DH750/STR-DH550

Connecting speakers

Connect each speaker as illustrated below.

Be sure to disconnect the AC power cord (mains lead) before connecting cables.

For details on how to connect speaker cables to the receiver, see “[How to connect speaker cables.](#)”

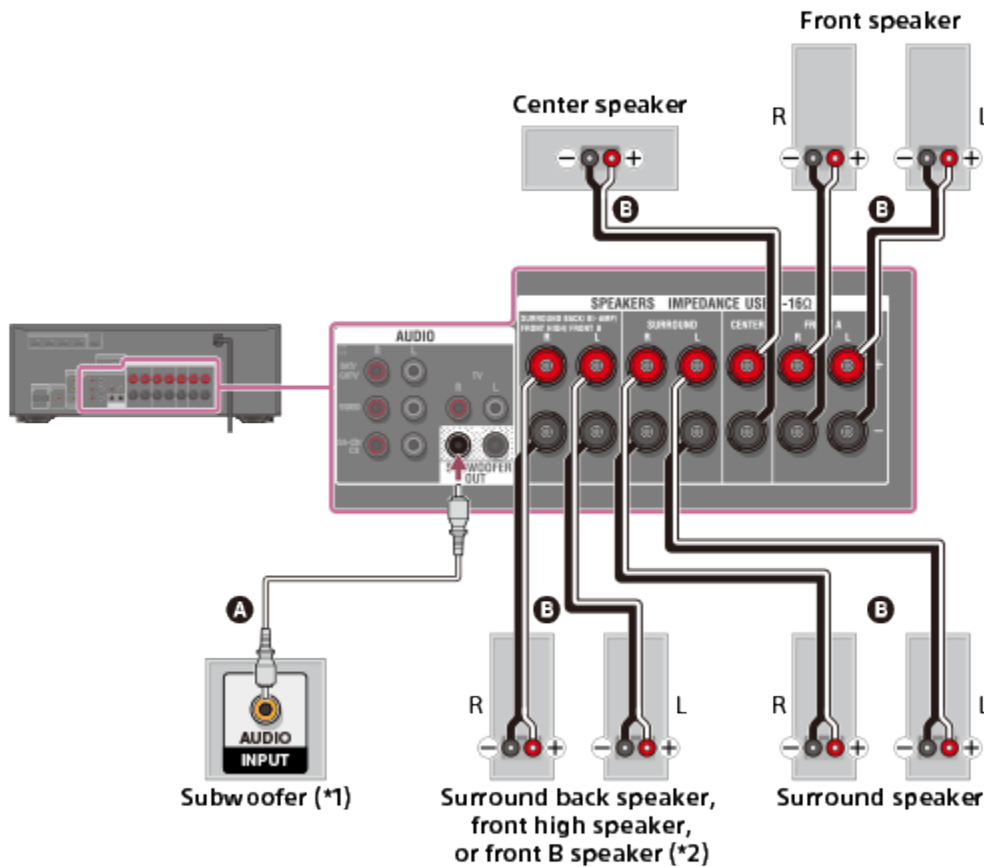

**A Monaural audio cable (not supplied)**

**B Speaker cable (not supplied)**

\*1 If you connect a subwoofer with an auto standby function, turn off this function when watching movies. If the auto standby function is turned on, it switches to standby mode automatically based on the level of the input signal to the subwoofer, and the sound may not be output.

\*2 For STR-DH750 only. Notes on connections to the SPEAKERS SURROUND BACK/BI-AMP/FRONT HIGH/FRONT B terminals

- If connecting only one surround back speaker, connect it to the L (+/-) terminals.
- If you have an additional front speaker system, connect it to these terminal. In this case, select a speaker pattern that does not have surround back and front high speakers. Then, set [SB Assign] in the Speaker Settings menu to [Speaker B]. You can select the front speaker system you want by using the SPEAKERS button on the receiver.
- You can connect the front speakers to these terminals using a bi-amplifier connection. In this case, set [SB

Assign] in the Speaker Settings menu to [Bi-Amp].

**Note**

- After you have installed and connected your speakers, be sure to select the speaker pattern you want using [Speaker Pattern] in the Speaker Settings menu.

Related Topic

- [Notes on connecting cables](#)
- [Using bi-amplifier connections \(for STR-DH750 only\)](#)
- [Selecting the speaker pattern \(Speaker Pattern\)](#)
- [Setting the assignment for the speaker terminals \(SB Assign\) \(for STR-DH750 only\)](#)

[Notes on use](#)

4-488-933-11(1)

Copyright 2014 Sony Corporation



MULTI CHANNEL AV RECEIVER  
STR-DH750/STR-DH550

## Connecting a TV

Connect a TV to HDMI TV OUT or MONITOR OUT jack. You can operate this receiver using an OSD (On-Screen Display) if you connect a TV to HDMI TV OUT jack.

Be sure to disconnect the AC power cord (mains lead) before connecting cables.

### Connecting a TV compatible with the Audio Return Channel (ARC) function via an HDMI connection

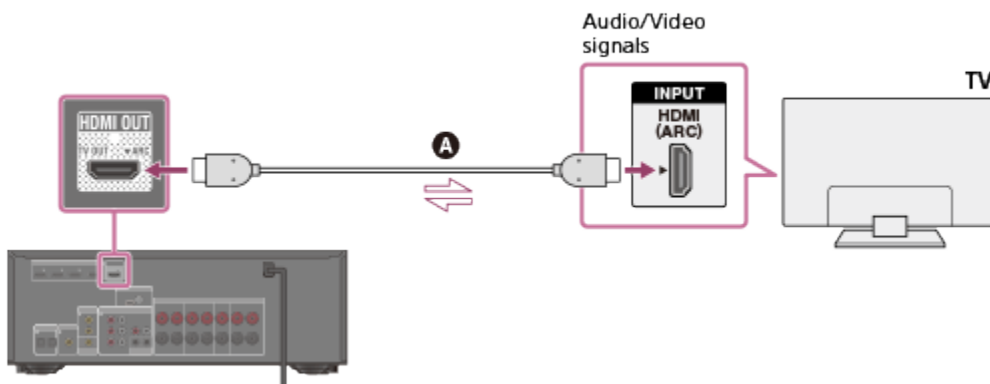

#### **A** HDMI cable (not supplied)

Sony recommends that you use an HDMI-authorized cable or Sony HDMI cable.

### Connecting a TV incompatible with the Audio Return Channel (ARC) function via an HDMI connection

The solid lines show recommended connections and the dashed lines show alternative connections.

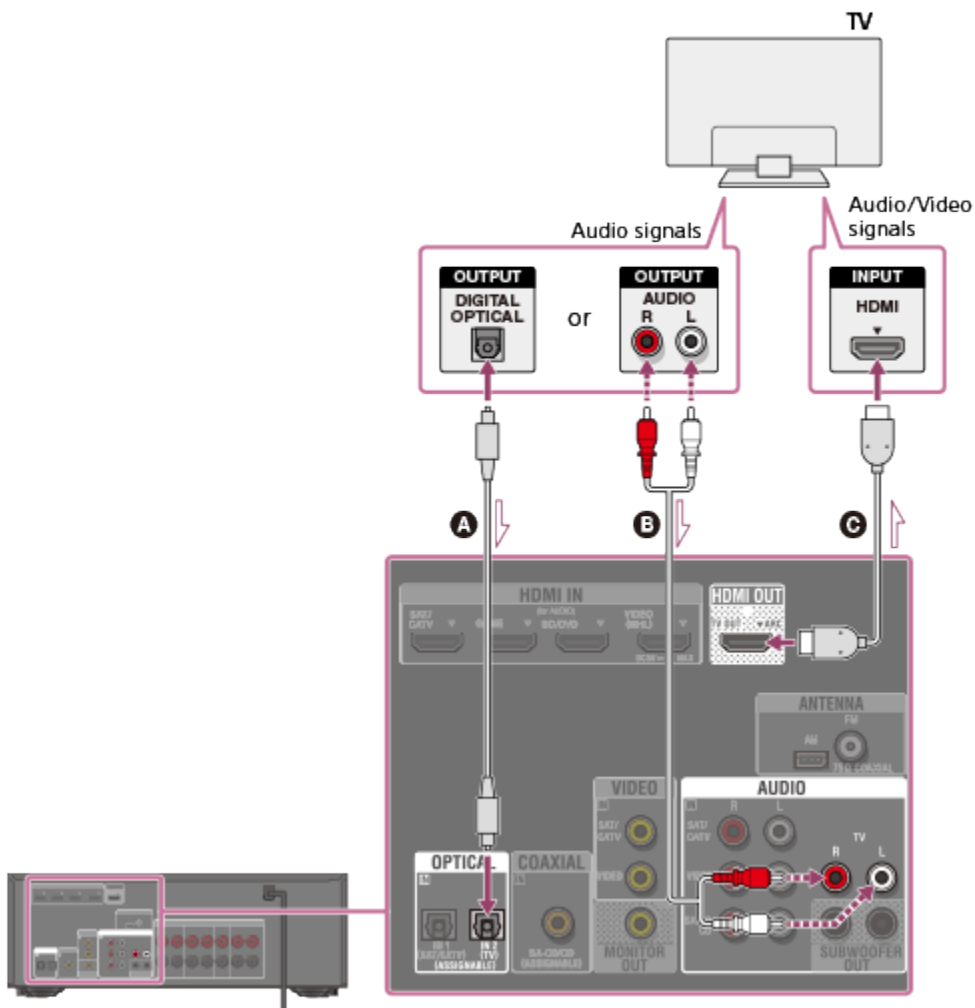

- Ⓐ Optical digital cable (not supplied)
- Ⓑ Audio cable (not supplied)
- Ⓒ HDMI cable (not supplied)

Sony recommends that you use an HDMI-authorized cable or HDMI cable made by Sony.

### Connecting a TV without HDMI jacks

The solid lines show recommended connections and the dashed lines show alternative connections.

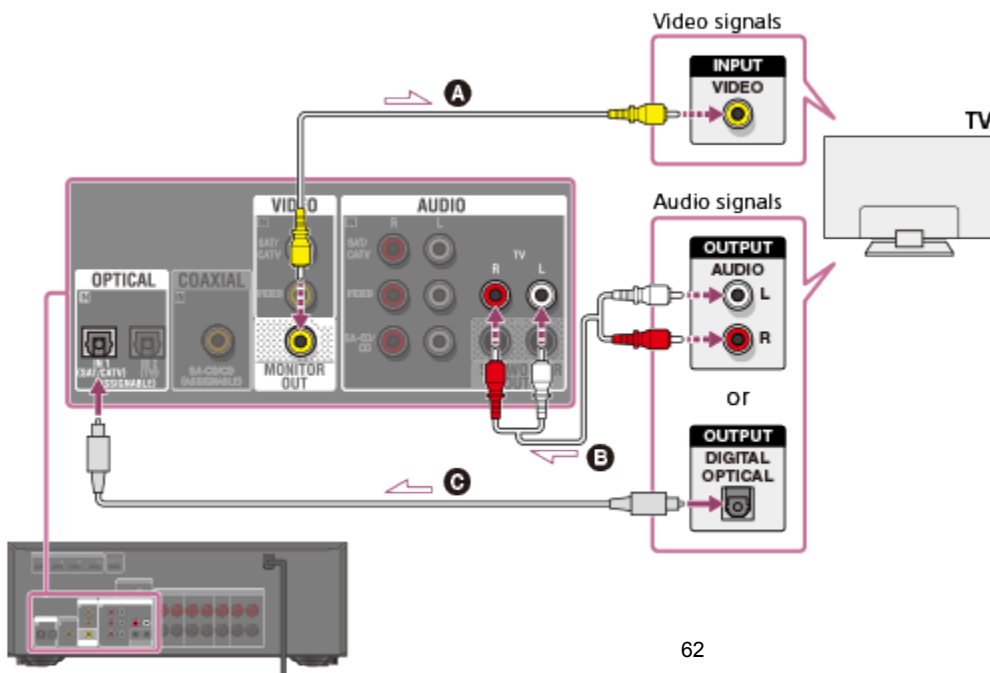

- Ⓐ Video cable (not supplied)
- Ⓑ Audio cable (not supplied)
- Ⓒ Optical digital cable (not supplied)

**Note**

- Connect a TV monitor or a projector to the HDMI TV OUT or MONITOR OUT jack on the receiver.
- Depending on the status of the connection between the TV and the antenna (aerial), the image on the TV screen may be distorted. If this is the case, place the antenna (aerial) farther away from the receiver.
- When connecting an optical digital cable, insert the plugs straight until they click into place.
- Do not bend or tie optical digital cables.

**Hint**

- All of the digital audio jacks are compatible with 32 kHz, 44.1 kHz, 48 kHz, and 96 kHz sampling frequencies.
- When connecting a TV to the receiver via the TV IN jacks of the receiver, set the sound output jack of the TV to Fixed if it can be switched between either Fixed or Variable.

Related Topic

- [Notes on connecting cables](#)
- [Enjoying sound of TV broadcasts from the receiver](#)
- [Controlling HDMI devices \(Control for HDMI\)](#)
- [Passing HDMI signals through \(Pass Through\)](#)
- [Setting the HDMI audio signal output of connected devices \(HDMI Audio Out\)](#)

[Notes on use](#)

4-488-933-11(1)

Copyright 2014 Sony Corporation



MULTI CHANNEL AV RECEIVER  
STR-DH750/STR-DH550

### Connecting devices with HDMI jacks

Connect devices to the receiver as illustrated below.

Before connecting cables, be sure to disconnect the AC power cord (mains lead).

If your device does not have an HDMI jack, see “[Connecting devices with jacks other than HDMI jacks.](#)”

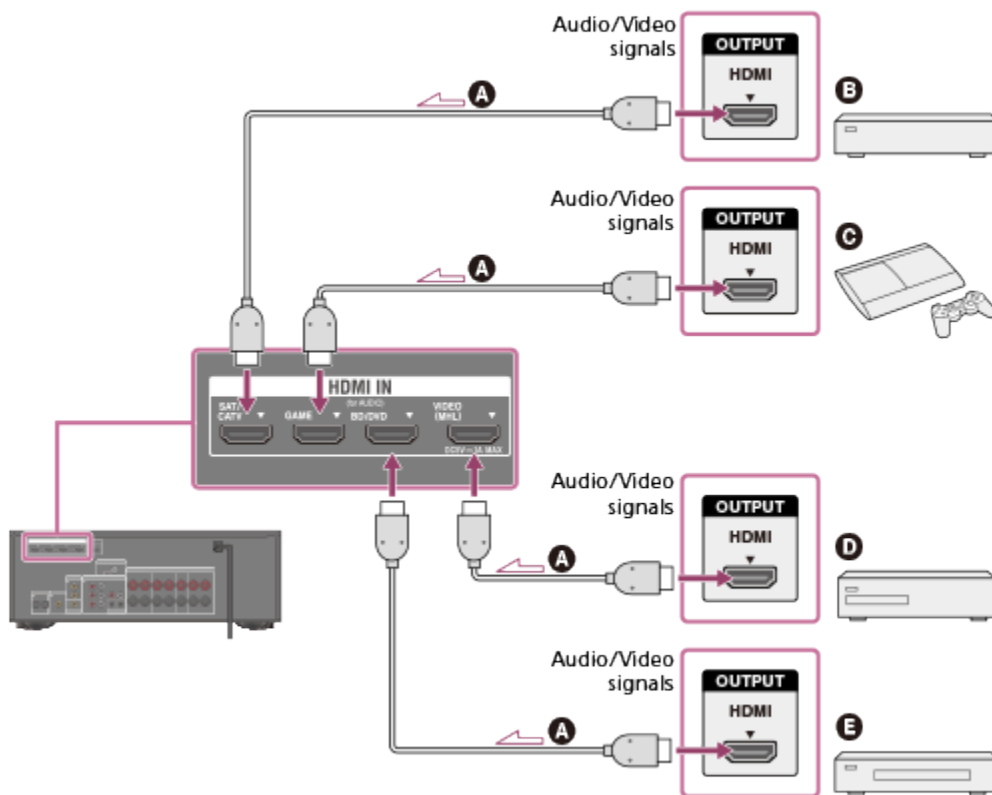

**A HDMI cable (not supplied)**

Sony recommends that you use an HDMI-authorized cable or Sony HDMI cable.

**B Satellite tuner, cable TV tuner**

**C PlayStation3**

**D DVD recorder**

**E Blu-ray Disc player, DVD player**

**Note**

- This HDMI connection is an example. You can connect each HDMI device to any HDMI input.
- The BD/DVD input has better sound quality. When you need a higher sound quality, connect your device to these jacks and select them as the input.

**Hint**

- The image quality depends on the connecting jack. We recommend that you connect your devices via an HDMI connection if they have HDMI jacks.

## Related Topic

- [Notes on connecting cables](#)
- [Using HDMI connections](#)
- [Changing the name for each input \(Name In\)](#)

## Notes on use

4-488-933-11(1)

Copyright 2014 Sony Corporation





MULTI CHANNEL AV RECEIVER  
STR-DH750/STR-DH550

Connecting devices with jacks other than HDMI jacks

Connect devices to the receiver as illustrated below.

The solid lines show recommended connections and the dashed lines show alternative connections.

Be sure to disconnect the AC power cord (mains lead) before connecting cables.

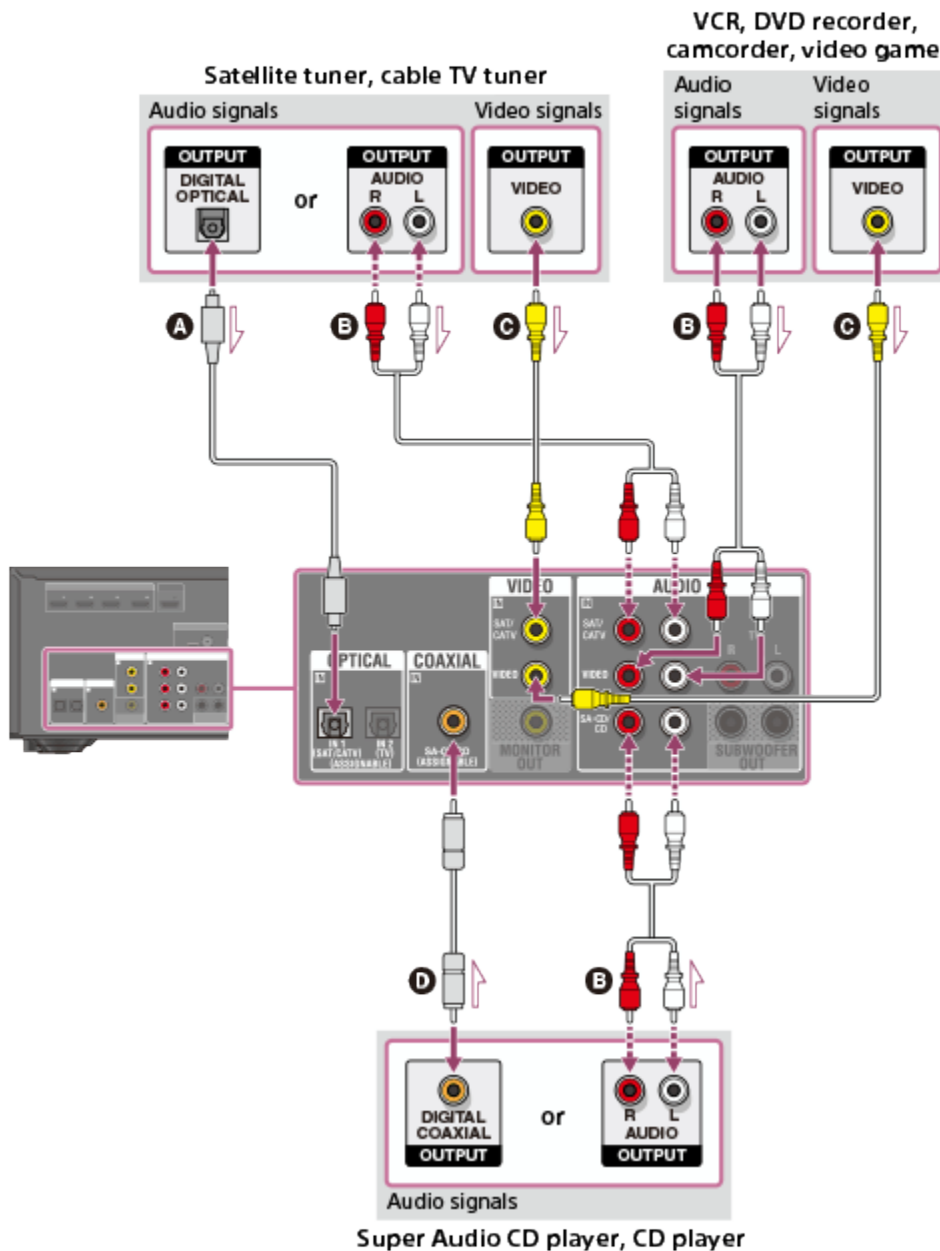

- Ⓐ Optical digital cable (not supplied)
- Ⓑ Audio cable (not supplied)
- Ⓒ Video cable (not supplied)
- Ⓓ Coaxial digital cable (not supplied)

## Related Topic

- [Notes on connecting cables](#)
- [Changing the name for each input \(Name In\)](#)
- [Using other video/audio input jacks \(Audio Input Assign\)](#)

## Notes on use

4-488-933-11(1)

Copyright 2014 Sony Corporation

MULTI CHANNEL AV RECEIVER  
STR-DH750/STR-DH550

## Connecting an iPhone, iPod, or USB device

Connect an iPhone, iPod or USB device as illustrated below.

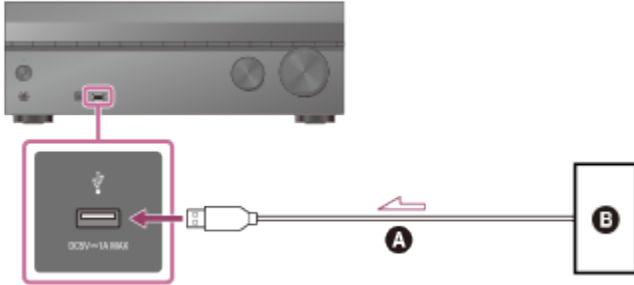

- A** USB cable (not supplied)
- B** iPhone, iPod, or USB device

[Notes on use](#)

4-488-933-11(1)

Copyright 2014 Sony Corporation



MULTI CHANNEL AV RECEIVER  
STR-DH750/STR-DH550

### Connecting an MHL-compatible mobile device

Connect an MHL-compatible mobile device as illustrated below.  
This receiver supports MHL 2 technology.

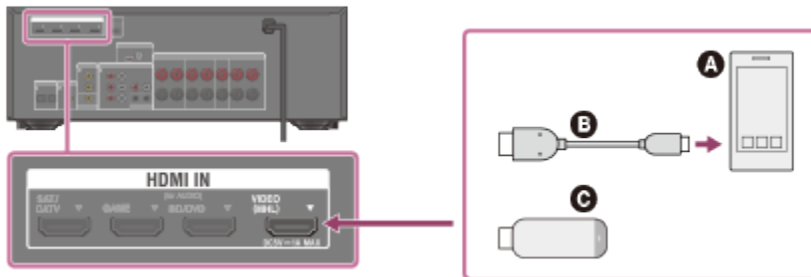

**A Mobile device**

**B MHL cable (not supplied)**

Use an MHL 2-compliant cable.

Sony recommends that you use an MHL cable made by Sony.

**C MHL Direct Attach Device**

#### Related Topic

- [Using MHL \(Mobile High-Definition Link\) connections](#)

#### Notes on use

4-488-933-11(1)

Copyright 2014 Sony Corporation

MULTI CHANNEL AV RECEIVER  
STR-DH750/STR-DH550

## Connecting the antennas (aerials)

Connect the supplied antennas (aerials) to the receiver as illustrated below.

Be sure to disconnect the AC power cord (mains lead) before connecting the antennas (aerials).

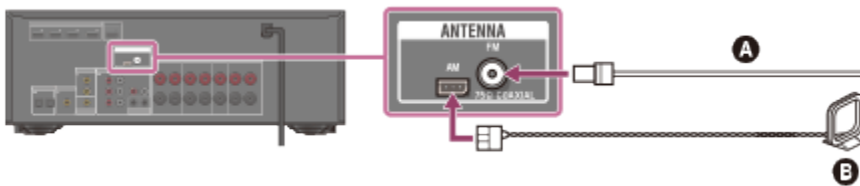

- A** FM wire antenna (aerial) (supplied)
- B** AM loop antenna (aerial) (supplied)

**Note**

- To prevent noise pickup, keep the AM loop antenna (aerial) away from the receiver and other devices.
- Be sure to fully extend the FM wire antenna (aerial).
- After connecting the FM wire antenna (aerial), keep it as horizontal as possible.

## Related Topic

- [Notes on connecting cables](#)

## Notes on use

4-488-933-11(1)

Copyright 2014 Sony Corporation



MULTI CHANNEL AV RECEIVER  
STR-DH750/STR-DH550

## Setting the voltage selector

---

If your receiver has a voltage selector on the rear panel, check that the voltage selector is set to the local power supply voltage. If not, use a screwdriver to set the selector to the correct position before connecting the AC power cord (mains lead) to a wall outlet.

The voltage selector may differ depending on the area.

### Notes on use

4-488-933-11(1)

Copyright 2014 Sony Corporation

MULTI CHANNEL AV RECEIVER  
STR-DH750/STR-DH550

## Inserting batteries into the remote control

Insert two R03 (size AAA) batteries (supplied) into the remote control. Make sure that the + and - ends are in the correct position when installing batteries.

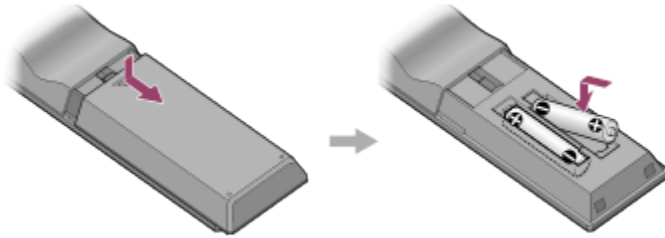
**Note**

- Do not leave the remote control in an extremely hot or humid place.
- Do not use a new battery with an old one.
- Do not mix manganese batteries with other kinds of batteries.
- Do not expose the remote control sensor to direct sunlight or lights. Doing so may cause a malfunction.
- If you do not intend to use the remote control for an extended period of time, remove the batteries to avoid possible damage from battery leakage and corrosion.
- When the receiver no longer responds to the remote control, replace both of the batteries with new ones.

## Notes on use

4-488-933-11(1)

Copyright 2014 Sony Corporation



MULTI CHANNEL AV RECEIVER  
STR-DH750/STR-DH550

## Turning on the receiver

---

When you have made all connections with the other devices, connect the AC power cord (mains lead), then turn on the receiver.

1. Connect the AC power cord (mains lead) to a wall outlet.

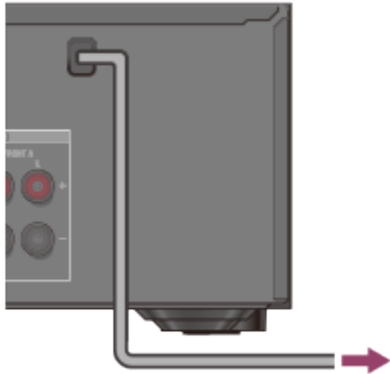

2. Press  $I/\text{power}$  (on/standby) to turn on the receiver.

$I/\text{power}$

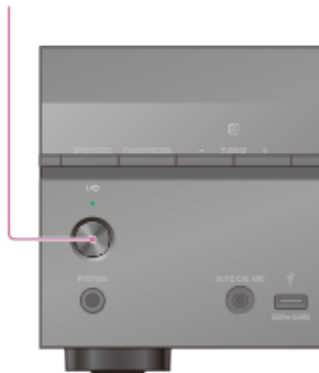

You can also turn on the receiver using  $I/\text{power}$  (on/standby) on the remote control. To turn off the receiver, press  $I/\text{power}$  (on/standby) again.

### Note

- After you turn off the receiver, [STANDBY] flashes on the display panel. Do not disconnect the AC power cord (mains lead) while [STANDBY] is flashing. This may cause a malfunction.

### Notes on use





MULTI CHANNEL AV RECEIVER  
STR-DH750/STR-DH550

## Setting up the receiver using the Easy Setup

---

When you turn on the receiver for the first time or after the receiver is initialized, the Easy Setup screen appears on the TV screen. You can set up the following settings for the receiver by following the instructions on the Easy Setup screen.

- **Speaker Settings**  
Perform automatic calibration in accordance with your speaker system configuration and arrangement.

### Note

- Switch the input of the TV to the input to which the receiver is connected to use this function.

If the Easy Setup screen does not appear or you want to display the Easy Setup screen manually, you can display it by selecting [Settings] - [Easy Setup] from the home menu.

### Related Topic

- [Adjusting the sound balance automatically \(Auto Calibration\)](#)

### Notes on use

4-488-933-11(1)

Copyright 2014 Sony Corporation



MULTI CHANNEL AV RECEIVER  
STR-DH750/STR-DH550

## Using the menu on the TV screen

---

You can display the menu of the receiver on the TV screen.

1. Switch the input of the TV to the input to which the receiver is connected.
2. Press HOME to display the home menu on the TV screen.



3. Press **↑/↓** repeatedly to select the menu you want, then press **⏏** to enter the menu.

### Home menu items

**Watch:** Select to display video from the connected device.

**Listen:** Select to listen to sound from the connected device.

**Sound Effects:** Select to enjoy sound effects.

**Settings:** Select to adjust the various settings for the receiver.

#### Hint

- When [OPTIONS] appears in the lower right portion of the TV screen, you can display the function list by pressing OPTIONS and selecting a related function.
- To return to the previous screen, press RETURN.
- To exit the menu, press HOME to display the home menu, then press HOME again.

### Notes on use

4-488-933-11(1)

Copyright 2014 Sony Corporation



MULTI CHANNEL AV RECEIVER  
STR-DH750/STR-DH550

## Enjoying video/sound from the connected device

---

1. Switch the input of the TV to the input to which the receiver is connected.
2. Press HOME.

The home menu is displayed on the TV screen.

Depending on the TV, the home menu may take some time to appear on the TV screen.



3. Select [Watch] or [Listen] from the home menu.  
The menu item list appears on the TV screen.
4. Select the device you want.
5. Turn on the device and start playback.
6. Press  $\triangle$ +/- to adjust the volume.  
You can also use MASTER VOLUME on the receiver.
7. Press A.F.D./2CH, MOVIE or MUSIC to enjoy the surround sound.  
You can also use A.F.D./2CH, MOVIE or MUSIC on the receiver. For details, see [“Selecting a sound field \(Sound Field\).”](#)

**Note**

- Before you turn off the receiver, be sure to turn down the volume level to avoid damaging your speakers.

**Hint**

- You can turn INPUT SELECTOR on the receiver or press the input buttons on the remote control to select the device you want.
- You can adjust the volume differently using the MASTER VOLUME knob on the receiver or the  $\triangle$ +/-

buttons on the remote control.

To turn the volume up or down quickly

- Turn the knob quickly.
- Press and hold one of the buttons.

To make fine adjustments

- Turn the knob slowly.
- Press one of the buttons and release it immediately.

### Notes on use

4-488-933-11(1)

Copyright 2014 Sony Corporation



MULTI CHANNEL AV RECEIVER  
STR-DH750/STR-DH550

## Compatible iPhone/iPod models

---

You can use the following iPhone/iPod models on this receiver. Update your iPhone/iPod with the latest software before using it.

### When connected via USB

- **iPhone:**  
iPhone 5s/iPhone 5c/iPhone 5/iPhone 4s/iPhone 4/iPhone 3GS/iPhone 3G
- **iPod touch:**  
iPod touch (2nd through 5th generation)
- **iPod:**  
iPod classic
- **iPod nano:**  
iPod nano (3rd through 7th generation)

### When connected via BLUETOOTH (for STR-DH750 only)

- **iPhone:**  
iPhone 5s/iPhone 5c/iPhone 5/iPhone 4s/iPhone 4/iPhone 3GS
- **iPod touch:**  
iPod touch (4th and 5th generation)

### [Notes on use](#)

4-488-933-11(1)

Copyright 2014 Sony Corporation

MULTI CHANNEL AV RECEIVER  
STR-DH750/STR-DH550Notes on iPhone/iPod

---

- Sony cannot accept responsibility in the event that data recorded to an iPhone/iPod is lost or damaged when using an iPhone/iPod connected to this receiver.
- iPhone/iPod is charged when connected to the receiver while the receiver is turned on.
- You cannot transfer songs onto the iPhone/iPod from the receiver.
- Do not remove the iPhone/iPod during operation. To avoid data corruption and damage to the iPhone/iPod, turn the receiver off when connecting or removing the iPhone/iPod.

## Related Topic

[● iPhone/iPod message list](#)[Notes on use](#)

4-488-933-11(1)

Copyright 2014 Sony Corporation



MULTI CHANNEL AV RECEIVER  
STR-DH750/STR-DH550

## Enjoying audio content stored on an iPhone/iPod via the USB port



---

You can enjoy music from an iPhone or iPod by connecting it to the  (USB) port on the receiver.

1. Select [Listen] - [USB] from the home menu.  
When an iPhone or iPod is connected, [iPod/iPhone] appears on the TV screen.
2. Follow the on-screen instructions to select the iPhone/iPod control mode.

### Operating an iPhone/iPod using the remote control

Press USB before you use the following buttons:

- ,  : Starts or pauses playback.
-  : Moves to the start of the previous/current or next track.
- **REPEAT**: Enters repeat mode.
- **SHUFFLE**: Enters shuffle mode.
- **iPhone CTRL**: Selects the iPod/iPhone control mode.

#### Related Topic

- [Connecting an iPhone, iPod, or USB device](#)

#### Notes on use

4-488-933-11(1)

Copyright 2014 Sony Corporation



MULTI CHANNEL AV RECEIVER  
STR-DH750/STR-DH550

## Enjoying audio content stored on a BLUETOOTH device (for STR-DH750 only)

---

1. Place the BLUETOOTH device within 1 meter (3.3 feet) of the receiver.
2. Press BLUETOOTH on the receiver to select the BLUETOOTH function.
3. Hold down BLUETOOTH for 2 seconds to activate the pairing mode of the receiver.  
[PAIRING] appears and [BT] flashes quickly on the display panel. Perform step 4 within five minutes, otherwise pairing will be canceled. In this case, repeat this step.
4. Perform pairing on the BLUETOOTH device to detect this receiver.  
For details, refer to the operating instructions of your BLUETOOTH device.  
A list of detected devices may appear on the BLUETOOTH device display depending on the type of BLUETOOTH device. This receiver is displayed as [STR-DH750].
5. Select [STR-DH750] on the BLUETOOTH device display.  
If [STR-DH750] is not displayed, repeat this process from step 1.
6. Check that the connection is completed and [BT] lights up on the display panel.
7. Start playback on the BLUETOOTH device.
8. Adjust the volume.  
Adjust the volume of the BLUETOOTH device first. If the volume level is still too low, adjust the volume level of the receiver.

### Canceling pairing operation

Hold down BLUETOOTH after step 3. [CANCEL] appears on the display panel.

#### Note

- When establishing a connection with this receiver in step 4, select the audio profile (A2DP or AVRCP) on the BLUETOOTH device. If the BLUETOOTH device does not support the AVRCP profile, you cannot perform playback or other operations on the receiver.
- If a passkey is required on the display of the BLUETOOTH device in step 5, enter [0000]. The passkey may be called "Passcode," "PIN code," "PIN number" or "Password."
- You can pair up to 9 BLUETOOTH devices. If a 10th BLUETOOTH device is paired, the least recently connected device will be replaced by the new one.

#### Hint

- On some types of BLUETOOTH devices, you can adjust the volume using the controls of the BLUETOOTH device.
- You can also activate the pairing mode of the receiver by the following ways:



– Press **OPTIONS** while the input is set to **[BLUETOOTH]**, then select **[Pair Device]**.

#### Related Topic

- [Controlling a BLUETOOTH device using the remote control \(for STR-DH750 only\)](#)
- [Checking the information of a connected BLUETOOTH device \(for STR-DH750 only\)](#)
- [Setting the Bluetooth Standby mode \(BT Standby\) \(for STR-DH750 only\)](#)
- [Setting BLUETOOTH audio codecs \(BT AAC/BT aptX\) \(for STR-DH750 only\)](#)

#### Notes on use

4-488-933-11(1)

Copyright 2014 Sony Corporation



MULTI CHANNEL AV RECEIVER  
STR-DH750/STR-DH550

## Compatible USB devices and USB specifications

---

### Verified Sony USB devices

You can use the following Sony USB devices on this receiver:

#### **Walkman:**

NW-A857/A860

NW-E053/E060/E083

NW-F800

NW-M505

NW-S756/S760/S770/S785

NW-WH303

NW-Z1000/Z1070

NWD-W260/W273

NWZ-A864

NWZ-B162F/B173F

NWZ-E053/E363/E373/E385/E463/E575/E585

NWZ-F805/F885

NWZ-S755/S764/S774

NWZ-W262/W272

NWZ-WH303/WH505

NWZ-Z1040/Z1070/Z1060

#### **MICROVAULT:**

USM1GL/4GL/8GL/32GL

USM16GLX/32GLX/64GLX

USM512J/8GJ

USM4GM

USM4GN/8GN/16(32)GN

USM64GP

USM8GQ/32GQ/64GQ

USM8GR/16GR/32GR

USM4GS/16GS

USM8GT

USM16GU

USM4GV

#### **Digital Voice Recorder:**

ICD-AX412

ICD-FX8

ICD-PX232/PX312F/PX333

ICD-SX813/SX1000

ICD-UX502/UX513F/UX523F/UX532/UX543

ICD-TX50

ICZ-R50/R51

PCM-D100

- The receiver is unable to read data in NTFS format.
- The receiver is unable to read data other than that saved in the first partition of a hard disk drive.
- Operation of models not listed here is not guaranteed.
- Operation may not always be guaranteed even when using these USB devices.
- Some of these USB devices may not be available for purchase in certain areas.
- When formatting the above models, be sure to format using the model itself or the dedicated formatting software for that model.
- When connecting a USB device to the receiver, be sure to connect after the display Creating Library or Creating Database on the USB device has disappeared.

## USB specifications

### Supported formats (\*1)

The music file formats that can be played back by this receiver are as follows:

#### **MP3 (MPEG 1 Audio Layer-3):**

32 kbps – 320 kbps, VBR

#### **WMA:**

48 kbps – 192 kbps

#### **AAC (\*2):**

48 kbps – 320 kbps, CBR, VBR

#### **WAV:**

8 kHz – 48 kHz, 16 bit PCM

\*1 Compatibility with all encoding/writing software, recording devices and recording media cannot be guaranteed.

\*2 The receiver does not play files encoded with DRM.

### Compatible USB device

Mass Storage Class

### Maximum current

500 mA

[Notes on use](#)

4-488-933-11(1)

Copyright 2014 Sony Corporation

MULTI CHANNEL AV RECEIVER  
STR-DH750/STR-DH550

## Notes on USB devices

- Do not remove a USB device during operation. To avoid data corruption and damage to the USB device, turn the receiver off when connecting or removing a USB device.
- Do not connect a USB device to the receiver through a USB hub.
- When a USB device is connected, [Reading] appears.
- It may take about 10 seconds before [Reading] appears depending on the type of USB device connected.
- When a USB device is connected, the receiver reads all of the files on the USB device. If there are many folders or files on the USB device, it may take a long time to finish reading the USB device.
- The receiver can recognize up to
  - \_ 256 folders (including [ROOT] folder).
  - \_ 256 audio files in each folder.
  - \_ 8 folder levels (tree structure of files, including [ROOT] folder).

The maximum number of audio files and folders may vary depending on the file and folder structure. Do not save other types of files or unnecessary folders on a USB device.

- Compatibility with all encoding/writing softwares, recording devices, and recording media cannot be guaranteed. Incompatible USB devices may produce noise or interrupted audio or may not play at all.
- Some time may be needed to start playback when:
  - \_ the folder structure is complex.
  - \_ the memory capacity is excessive.
- This receiver does not necessarily support all of the functions provided in a connected USB device.
- The playback order for the receiver may differ from the playback order of the connected USB device.
- If folders that have no audio files are selected, [No track] appears.
- When playing a very long track, some operations may cause playback delay.

## Related Topic

- [USB message list](#)

## Notes on use

4-488-933-11(1)

Copyright 2014 Sony Corporation



MULTI CHANNEL AV RECEIVER  
STR-DH750/STR-DH550

## Enjoying audio content stored on a USB device

---



You can enjoy music from a USB device by connecting it to the  (USB) port on the receiver.

1. Select [Listen] - [USB] from the home menu.

When the USB device is connected, [USB] appears on the TV screen. You can operate the USB device using the remote control of the receiver.

### Operating the USB device using the remote control

Press USB before you use the following buttons:

- : Starts or pauses playback.
- : Stops playback.
- : Moves to the start of the previous/current or next track.
- **REPEAT**: Enters repeat mode.
- **SHUFFLE**: Enters shuffle mode.

#### Related Topic

- [Connecting an iPhone, iPod, or USB device](#)

#### Notes on use

4-488-933-11(1)

Copyright 2014 Sony Corporation



MULTI CHANNEL AV RECEIVER  
STR-DH750/STR-DH550

## Listening to FM/AM radio

You can listen to FM and AM broadcasts through the built-in tuner. Before operation, be sure you have connected the FM and AM antennas (aerials) to the receiver.

1. Select [Listen] - [FM] or [AM] from the home menu.  
The FM/AM screen appears.

### FM/AM screen

You can select and operate each item on the screen by pressing  $\uparrow/\downarrow/\leftarrow/\rightarrow$  and  $\blacksquare$ .

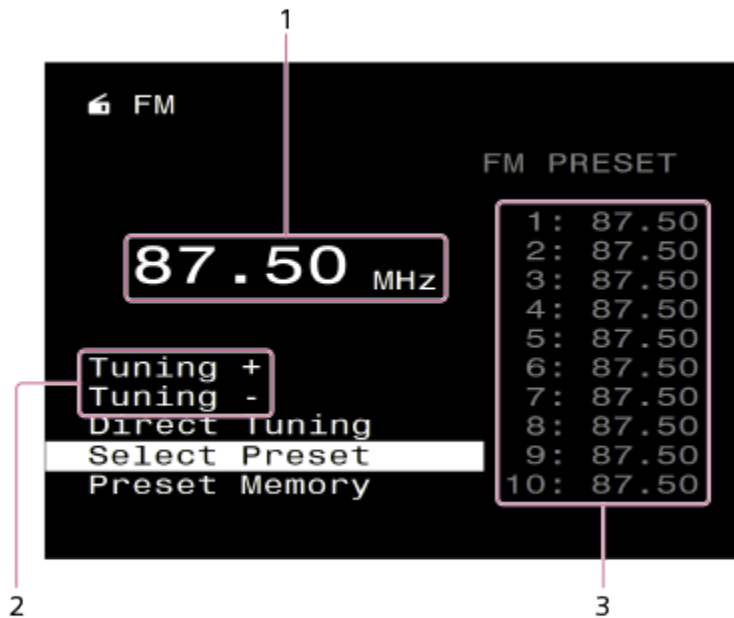

1. **Frequency indication**

2. **Tuning +/Tuning -**

Select [Tuning +] to scan from lower to higher frequency stations, select [Tuning -] to scan from higher to lower stations. The receiver stops scanning whenever a station is received.

3. **Preset station list**

You can tune to a station by selecting the preset number from the list.

#### Related Topic

- [Connecting the antennas \(aerials\)](#)



MULTI CHANNEL AV RECEIVER  
STR-DH750/STR-DH550

## Presetting FM/AM radio stations (Preset Memory)

---

You can store up to 30 FM and 30 AM stations as your favorite stations.

1. Select [Listen] - [FM] or [AM] from the home menu.
2. Tune to the station that you want to preset.
3. Select [Preset Memory].
4. Select a preset number.  
The station is stored as the selected preset number.
5. Repeat steps 1 to 4 to store another station.

You can store stations as follows:

- AM band: AM 1 to AM 30
- FM band: FM 1 to FM 30

### Related Topic

- [Naming preset stations \(Name Input\)](#)

### Notes on use

4-488-933-11(1)

Copyright 2014 Sony Corporation

MULTI CHANNEL AV RECEIVER  
STR-DH750/STR-DH550

## Tuning to a station directly (Direct Tuning)

You can enter the frequency of a station directly.

1. Select [Listen] - [FM] or [AM] from the home menu.
2. Select [Direct Tuning]
3. Enter the frequency using  $\uparrow / \downarrow / \leftarrow / \rightarrow$ .
  - i. Press  $\uparrow / \downarrow$  to change the digit.
  - ii. Press  $\leftarrow / \rightarrow$  to select a digit.
4. Press  $\blacksquare$ .

**Note**

- If the tuned frequency is invalid or out of range, [---.--- MHz] or [---- kHz] appears and then the screen returns to the current frequency.  
Make sure you have entered the right frequency. If not, repeat steps 3 and 4. If you still cannot tune to a station, the frequency may not be in use in your area.

**Hint**

- Adjust the direction of the AM loop antenna (aerial) for optimum reception upon tuning to an AM station.
- The tuning scale for direct tuning is shown below:
  - **USA and Canada**  
FM: 100 kHz  
AM: 10 kHz (\*)
  - **Europe and Australia**  
FM: 50 kHz  
AM: 9 kHz

\* The AM tuning scale can be changed. For details, see “ [Changing the AM tuning scale \(for USA and Canadian models only\)](#).”

## Notes on use

4-488-933-11(1)

Copyright 2014 Sony Corporation





MULTI CHANNEL AV RECEIVER  
STR-DH750/STR-DH550

## Changing the AM tuning scale (for USA and Canadian models only)

---

You can change the AM tuning scale to either 9 kHz or 10 kHz using the buttons on the receiver. Be sure to use the buttons on the receiver to perform this operation.

1. Turn off the receiver.
2. Hold down TUNING MODE and press  $I/\cup$  (on/standby) on the receiver.  
The current AM tuning scale is changed to 9 kHz (or 10 kHz). To reset the scale to 10 kHz (or 9 kHz), repeat the procedure above.

### Note

- Depending on the settings, the receiver may take some time to change the AM tuning scale.
- All preset stations will be erased when you change the tuning scale.

### Notes on use

4-488-933-11(1)

Copyright 2014 Sony Corporation



MULTI CHANNEL AV RECEIVER  
STR-DH750/STR-DH550

## Receiving RDS broadcasts (for European and Australian models only)

---

This receiver allows you to use Radio Data System (RDS), which enables FM radio stations (\*) to send additional information along with the regular programming signal. This receiver offers convenient RDS features, such as Program Service name display.

\* Not all FM stations provide RDS service, nor do they provide the same type of services. If you are not familiar with the RDS services in your area, check with your local radio stations for details.

1. Select [Listen] - [FM] from the home menu.

2. Select a station.

When you tune to a station that provides RDS services, the Program Service name appears on the TV screen and the display panel.

### Note

- RDS may not work properly if the station you tuned to does not transmit the RDS signal or if the signal strength is weak.
- Some letters that can be displayed on the TV screen cannot be displayed on the display panel.

### Hint

- You can check the frequency while a Program Service name is displayed by pressing DISPLAY repeatedly.

### Notes on use

4-488-933-11(1)

Copyright 2014 Sony Corporation

MULTI CHANNEL AV RECEIVER  
STR-DH750/STR-DH550

## Selecting a sound field (Sound Field)

You can select from a variety of sound field modes according to speaker connections or input sources.

1. Select [Settings] - [Audio Settings] from the home menu.
2. Select [Sound Field].
3. Select the sound field you want.

For details on each sound field, see the following topics.

- [Auto Format Direct \(A.F.D.\)/2-channel sound mode](#)
- [Movie mode](#)
- [Music mode](#)
- [When headphones are connected](#)

**Note**

- The sound fields for movie and music may not work, depending on the input or the speaker pattern you select, or with audio formats.
- The receiver may play signals at a lower sampling frequency than the actual sampling frequency of the input signals, depending on the audio format.
- [PLIIX Movie] or [PLIIX Music] may not appear, depending on the speaker pattern you select (for STR-DH750 only).
- Some speakers or the subwoofer may not output sound, depending on the sound field setting.
- If there is any noise present, the noise may be different, depending on the sound field you select.

**Hint**

- You can also select [Sound Field] in [Sound Effects] from the home menu.
- You can also use A.F.D./2CH, MOVIE or MUSIC on the remote control or the receiver to select a sound field.

[Notes on use](#)

4-488-933-11(1)

Copyright 2014 Sony Corporation



MULTI CHANNEL AV RECEIVER  
STR-DH750/STR-DH550

## Resetting sound fields to the default settings

---

Be sure to use the buttons on the receiver to perform this operation.

1. Turn off the receiver.
2. Hold down MUSIC and press  $\text{I/}\text{O}$  (on/standby) on the receiver.  
[S.F. CLEAR] appears on the display panel and all sound fields are reset to their default setting.

### Notes on use

4-488-933-11(1)

Copyright 2014 Sony Corporation



MULTI CHANNEL AV RECEIVER  
STR-DH750/STR-DH550

## Notes on sound fields

---

- Depending on the speaker pattern settings, some sound fields may not be available.
- You cannot select [PLIIX Movie] (\*) and [PLIIX Music] (\*) at the same time.
  - [PLIIX Movie] (\*) and [PLIIX Music] (\*) are available only when the speaker pattern is set to a setting with surround back speaker(s).
- The sound fields for music and movies do not work in the following cases:
  - DTS-HD Master Audio, DTS-HD High Resolution Audio or Dolby TrueHD with a sampling frequency higher than 48 kHz are being received.
  - [Analog Direct] is selected.
- [PLII Movie], [PLII Music], [PLIIX Movie] (\*), [PLIIX Music] (\*), [Neo:6 Cinema] (\*) and [Neo:6 Music] (\*) do not work when the speaker pattern is set to [2/0] or [2/0.1].
- When one of the sound fields for music is selected, no sound is output from the subwoofer if all of the speakers are set to [Large] in the Speaker Settings menu. However, the sound will be output from the subwoofer if:
  - the digital input signal contains LFE signals.
  - the front or surround speakers are set to [Small].
  - [Multi Stereo], [PLII Movie], [PLII Music], [PLIIX Movie] (\*), [PLIIX Music] (\*), [HD-D.C.S.] or [Portable Audio] is selected.

\* For STR-DH750 only

### If you connect a subwoofer

This receiver will generate a low frequency signal for output to the subwoofer when there is no LFE signal, which is a low-pass sound effect output from a subwoofer to a 2-channel signal. However, the low frequency signal is not generated for [Neo:6 Cinema] (\*) or [Neo:6 Music] (\*) if all of the speakers are set to [Large]. In order to take full advantage of the Dolby Digital bass redirection circuitry, we recommend setting the subwoofer's cutoff frequency as high as possible.

\* For STR-DH750 only

### Notes on use

4-488-933-11(1)

Copyright 2014 Sony Corporation



MULTI CHANNEL AV RECEIVER  
STR-DH750/STR-DH550

## Enjoying clear sound at a low volume level (Night Mode)

---

This function allows you to retain a theater-like environment at low volume levels. When watching a movie late at night, you will be able to hear the dialog clearly even at a low volume level. This function can be used with other sound fields.

1. Select [Settings] - [Audio Settings] from the home menu.
2. Select [Night Mode].
3. Select [On] or [Off].

### Note

- This function does not work when [Analog Direct] is selected.

### Hint

- You can also set the Night Mode function on and off by using NIGHT MODE on the receiver.
- While the Night Mode is turned on, the bass, treble, and effect levels increase, and [D.Range Comp.] is automatically set to [On].

### Notes on use

4-488-933-11(1)

Copyright 2014 Sony Corporation

MULTI CHANNEL AV RECEIVER  
STR-DH750/STR-DH550

## Adjusting the equalizer (Equalizer)

You can use the following parameters to adjust the tonal quality (bass/treble level) of the front speakers.

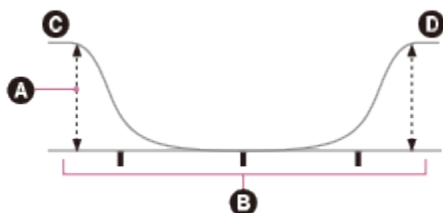

- A** Level (dB)
- B** Frequency (Hz)
- C** Bass
- D** Treble

1. Select [Settings] - [Audio Settings] from the home menu.
2. Select [Equalizer].
3. Select the gain of [Bass] or [Treble].
4. Adjust the gain.

**Note**

- This function does not work when [Analog Direct] is being used.
- Frequencies for [Bass] and [Treble] are fixed.
- Depending on the audio format, the receiver may play signals at a lower sampling frequency than the original sampling frequency of the input signals.

**Hint**

- You can also select [Equalizer] in [Sound Effects] from the home menu.

## Notes on use

4-488-933-11(1)

Copyright 2014 Sony Corporation



MULTI CHANNEL AV RECEIVER  
STR-DH750/STR-DH550

## Selecting the Auto Calibration type (Calibration Type)

---

You can select a calibration type after you have performed the Auto Calibration and saved the settings.

1. Select [Settings] - [Speaker Settings] from the home menu.
2. Select [Calibration Type].
3. Select the setting you want.
  - **Full Flat:** Makes the measurement of frequency from each speaker flat.
  - **Engineer:** Sets to “the Sony listening room standard” frequency characteristics.
  - **Front Ref. (Front Reference):** Adjusts the characteristics of all of the speakers to match the characteristics of the front speaker.
  - **Off**

### Note

- This function does not work in the following cases:
  - [Analog Direct] is being used.
  - Headphones are connected.
- The receiver may play signals at a lower sampling frequency than the actual sampling frequency of the input signals, depending on the audio format.

### Hint

- You can also select [Calibration Type] in [Sound Effects] from the home menu.

### Notes on use

4-488-933-11(1)

Copyright 2014 Sony Corporation





MULTI CHANNEL AV RECEIVER  
STR-DH750/STR-DH550

## Enjoying high-fidelity sound (Pure Direct)

---

You can enjoy higher-fidelity sound from all inputs using the Pure Direct function. When the Pure Direct function is on, the display panel lights off to suppress noise that affects sound quality.

1. Select [Sound Effects] - [Pure Direct] from the home menu.
2. Select [On].

### Canceling Pure Direct

The Pure Direct function will be canceled when you perform the following:

- Select [Off] in step 2.
- Press PURE DIRECT on the receiver.
- Change the sound field.
- Change the scene setting on the TV (Scene Select).
- Change the setting of [Equalizer], [Night Mode], [Auto Volume] or [D.Range Comp].

#### Note

- [Equalizer], [Night Mode], [Auto Volume] and [D.Range Comp] do not work when the Pure Direct function is selected.

#### Hint

- You can also use the PURE DIRECT button on the receiver to turn the Pure Direct function on or off.

### Notes on use

4-488-933-11(1)

Copyright 2014 Sony Corporation



MULTI CHANNEL AV RECEIVER  
STR-DH750/STR-DH550

## Compatible BLUETOOTH version and profiles (for STR-DH750 only)

---

“Profile” refers to a standard set of capabilities for various BLUETOOTH product capabilities. This receiver supports the following BLUETOOTH version and profiles:

- **Compatible BLUETOOTH version:** BLUETOOTH Specification Version 3.0
- **Compatible BLUETOOTH profiles:**
  - A2DP (Advanced Audio Distribution Profile): Receives high-quality audio content.
  - AVRCP 1.3 (Audio Video Remote Control Profile): Controls audio/video devices (pausing, stopping, starting playback, volume control, etc.) for the latest information about compatible BLUETOOTH devices.

Check the websites listed under “[Customer support websites](#).”

### Note

- To use the BLUETOOTH function, the BLUETOOTH device to be connected must support the same profile as this receiver. Even if the device supports the same profile, the functions may differ depending on the specifications of the BLUETOOTH device.
- The audio playback on this receiver may be delayed from that on the BLUETOOTH device because of the characteristics of the BLUETOOTH wireless technology.

### Notes on use

4-488-933-11(1)

Copyright 2014 Sony Corporation



MULTI CHANNEL AV RECEIVER  
STR-DH750/STR-DH550

### Turning the BLUETOOTH function on/off (BT Power) (for STR-DH750 only)

---

You can turn the BLUETOOTH function on or off. The NFC function is also turned on/off in conjunction with this setting.

1. Press BLUETOOTH on the receiver.  
You can also select [Listen] - [BLUETOOTH] from the home menu.
2. Press OPTIONS.  
The option menu appears.
3. Select [BT Power] .
4. Select [BT On] or [BT Off].

#### Notes on use

4-488-933-11(1)

Copyright 2014 Sony Corporation



MULTI CHANNEL AV RECEIVER  
STR-DH750/STR-DH550

## Enjoying audio content stored on a BLUETOOTH device with a one-touch connection (NFC) (for STR-DH750 only)

You can enjoy audio content on a BLUETOOTH device with a one-touch connection using the NFC function.

1. Download the NFC Easy Connect application to your mobile device.



You do not need to install the NFC Easy Connect application if you are using an NFC-compatible mobile device with Android OS 4.1 or later installed.

2. Touch the **N** mark on the receiver with your mobile device.

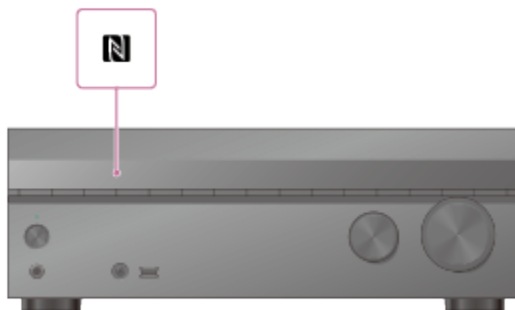

3. Check that the connection is completed and [BT] lights up on the display panel.
4. Start playback on the BLUETOOTH device.
5. Adjust the volume.  
Adjust the volume of the BLUETOOTH device first. If the volume level is still too low, adjust the volume level of the receiver.

### Compatible smartphones



Smartphones with the NFC function (compatible OS: Android 2.3.3 or later)

### Notes on use

MULTI CHANNEL AV RECEIVER  
STR-DH750/STR-DH550

## Controlling a BLUETOOTH device using the remote control (for STR-DH750 only)

You can operate a BLUETOOTH device using the following buttons on the remote control:

- : Starts or pauses playback.
- : Stops playback.
- : Moves to the start of the previous/current or next track.

**Note**

- These operations may not be available for certain BLUETOOTH devices. The actual operations may also differ depending on the connected BLUETOOTH device.

## Related Topic

- [Checking the information of a connected BLUETOOTH device \(for STR-DH750 only\)](#)
- [Setting the Bluetooth Standby mode \(BT Standby\) \(for STR-DH750 only\)](#)
- [Setting BLUETOOTH audio codecs \(BT AAC/BT aptX\) \(for STR-DH750 only\)](#)

## Notes on use

4-488-933-11(1)

Copyright 2014 Sony Corporation



MULTI CHANNEL AV RECEIVER  
STR-DH750/STR-DH550

## Controlling the receiver using a smartphone or tablet device (SongPal) (for STR-DH750 only)

“SongPal” enhances music visually with your smartphone display. You can choose music/audio contents from integrated functions of various device and smartphone, and control various settings intuitively.

A dedicated App for this model is available on both Google Play and App Store.

Search for “SongPal” and download the free App to find out more about the convenient features.

Easy Control app, “SongPal”, supports wireless operation. It allows you to:

- choose music/audio contents from integrated functions of various devices and smartphone.
- control various settings intuitively.
- enhance the music visually with your smartphone display.

1. Download the “SongPal” application to your mobile device.
2. Run “SongPal” and follow the on-screen instructions.
3. Connect your mobile device to the receiver using the NFC function or by manual operation.  
After the connection is completed, you can control the receiver using “SongPal.”

### Note

- “SongPal” does not support the iPad.

### Related Topic

- [Notes on iPhone/iPod](#)
- [Compatible BLUETOOTH version and profiles \(for STR-DH750 only\)](#)
- [Enjoying audio content stored on a BLUETOOTH device with a one-touch connection \(NFC\) \(for STR-DH750 only\)](#)
- [SongPal application is closed \(for STR-DH750 only\).](#)

### Notes on use

4-488-933-11(1)

Copyright 2014 Sony Corporation



MULTI CHANNEL AV RECEIVER  
STR-DH750/STR-DH550

## What is “BRAVIA” Sync?

---

The “BRAVIA” Sync function allows communication between Sony products such as TVs, Blu-ray Disc players, DVD players, and AV amplifiers that support the Control for HDMI function.

Control for HDMI is a mutual control function standard used by HDMI CEC (Consumer Electronics Control) for HDMI (High-Definition Multimedia Interface).

We recommend that you connect the receiver to products featuring “BRAVIA” Sync.

### Notes on use

4-488-933-11(1)

Copyright 2014 Sony Corporation



MULTI CHANNEL AV RECEIVER  
STR-DH750/STR-DH550

## Preparing for “BRAVIA” Sync

---

Turn on the Control for HDMI function of the receiver and the connected device to individually.

1. Select [Settings] - [HDMI Settings] from the home menu.
2. Select [Control for HDMI].
3. Select [On].  
The Control for HDMI function of the receiver is turned on.
4. Press HOME to exit the OSD menu.
5. Select the HDMI input of the receiver and TV to match the HDMI input of the connected device, so that the image from the connected device is displayed.
6. Turn on the Control for HDMI function of the connected device.  
For details on setting the TV and connected device, refer to the operating instructions of the respective devices.
7. Repeat steps 5 and 6 for other devices for which you want to use the Control for HDMI function.

### Note

- Perform the steps above again if you unplug the HDMI cable or change the connection.

### Notes on use

4-488-933-11(1)

Copyright 2014 Sony Corporation





MULTI CHANNEL AV RECEIVER  
STR-DH750/STR-DH550

## Interlocking other devices using an HDMI connection (“BRAVIA” Sync)

---

By connecting Sony devices that support the “BRAVIA” Sync using an HDMI cable (not supplied), operations are simplified as follows:

- [Enjoying an input source from a connected device immediately \(One-Touch Play\)](#)
- [Enjoying TV sound from the speakers connected to the receiver \(System Audio Control\)](#)
- [Turning off the receiver and connected devices simultaneously with the TV \(System Power-Off\)](#)
- [Selecting the optimum picture quality and sound field automatically \(Scene Select\)](#)
- [Home Theatre Control](#)
- [Operating the receiver menu using the TV remote control \(Remote Easy Control\)](#)

### Note

- The “One-Touch Play,” “System Audio Control,” and “System Power-Off” functions can be used with non-Sony devices. However, compatibility with all non-Sony devices is not guaranteed.
- The “Scene Select” and “Home Theatre Control” functions are Sony proprietary functions. These cannot operate with non-Sony devices.
- Devices incompatible with “BRAVIA” Sync cannot activate these features.
- Some of the operations may be supported when you connect an MHL device.

### Notes on use

4-488-933-11(1)

Copyright 2014 Sony Corporation



MULTI CHANNEL AV RECEIVER  
STR-DH750/STR-DH550

## Enjoying sound of TV broadcasts from the receiver

---

If your TV supports the Audio Return Channel (ARC) function, set the receiver by the following procedure to output the sound of the TV from the speakers connected to the receiver.

1. Select [Settings] - [HDMI Settings] from the home menu.
2. Select [Control for HDMI].
3. Select [On].

**If you connect to a TV that is not compatible with the Audio Return Channel (ARC) function or you want to select an audio signal using a cable other than an HDMI cable (e.g. via an optical digital cable or an audio cable)**

Switch the audio input mode. For details, see "[Switching between digital and analog audio \(Input Mode\).](#)"

### Note

- Be sure to turn off the volume of the TV or activate the muting function of the TV.
- If your TV does not support the System Audio Control function, set [HDMI Audio Out] to [TV+AMP] in the HDMI Settings menu to output the sound of the TV from the TV speaker and the speakers connected to the receiver.

### Related Topic

- [Switching between digital and analog audio \(Input Mode\)](#)
- [Connecting a TV](#)

### Notes on use

4-488-933-11(1)

Copyright 2014 Sony Corporation

MULTI CHANNEL AV RECEIVER  
STR-DH750/STR-DH550

## Switching between digital and analog audio (Input Mode)

When you connect devices to both digital and analog audio input jacks on the receiver, you can fix the audio input mode to either device, or switch from one to the other, depending on the type of material you intend to watch.

1. Press the input buttons to select the input.
2. Select [Settings] - [Input Settings] from the home menu.
3. Select [Input Mode].
  - **Auto:** Gives priority to digital audio signals. If there is more than one digital connection, HDMI audio signals have priority.  
If there is no digital audio signals, analog audio signals are selected. When TV input is selected, priority is given to Audio Return Channel (ARC) signals. If your TV supports the ARC function, digital optical audio signals are selected.
  - **Optical:** Specifies input of digital audio signals to the OPTICAL jack.
  - **Coaxial:** Specifies input of digital audio signals to the COAXIAL jack.
  - **Analog:** Specifies input of analog audio signals to the AUDIO IN (L/R) jacks.

**Note**

- Depending on the input, [Input Mode] may be dimmed on the TV screen and other modes cannot be selected.
- When [Analog Direct] is being used, audio input is set to [Analog]. You cannot select other modes.

**Hint**

- You can also use INPUT SELECTOR on the receiver to select the input in step 1.

## Notes on use

4-488-933-11(1)

Copyright 2014 Sony Corporation



MULTI CHANNEL AV RECEIVER  
STR-DH750/STR-DH550

## Using other video/audio input jacks (Audio Input Assign)

---

You can reassign the OPTICAL/COAXIAL digital audio input jacks to other input if the default settings of the jacks do not correspond to your connected equipment.

E.g. When connecting a DVD player to the OPTICAL IN 1 (SAT/CATV) jack, assign the OPTICAL IN 1 (SAT/CATV) jack to [BD/DVD].

1. Select [Settings] - [Input Settings] from the home menu.
2. Select [Audio Input Assign].
3. Select the input name you want to assign.
4. Select the jack you want to assign to the input.

### Assignable audio input jacks

#### OPT 1:

BD/DVD , SAT/CATV (\*), GAME, VIDEO , SA-CD/CD

#### OPT 2:

BD/DVD , SAT/CATV, GAME, VIDEO, SA-CD/CD

#### COAX:

BD/DVD , SAT/CATV, GAME, VIDEO , SA-CD/CD (\*)

#### None:

BD/DVD (\*), SAT/CATV, GAME (\*), VIDEO (\*), SA-CD/CD

\* Default setting

#### Note

- When you assign the digital audio input, the Input Mode setting may change automatically.
- One reassignment is allowed for each input.
- If no sound is output from the jacks which you have assigned, also check the Input Mode settings.

### Notes on use

4-488-933-11(1)

Copyright 2014 Sony Corporation



MULTI CHANNEL AV RECEIVER  
STR-DH750/STR-DH550

## Adjusting the sound balance automatically (Auto Calibration)

---

This receiver is equipped with a D.C.A.C. (Digital Cinema Auto Calibration) function which allows you to perform automatic calibration. For details on performing this function, see the following topics:

- [Before you perform Auto Calibration](#)
- [Connecting the optimizer microphone](#)
- [Selecting the front speakers \(for STR-DH750 only\)](#)
- [Performing Auto Calibration](#)

### Related Topic

- [About Auto Calibration](#)
- [Confirming active subwoofer setup](#)

### Notes on use

4-488-933-11(1)

Copyright 2014 Sony Corporation



MULTI CHANNEL AV RECEIVER  
STR-DH750/STR-DH550

Using bi-amplifier connections (for STR-DH750 only)

If you are not using surround back speakers or front high speakers, you can connect the front speakers to the SPEAKERS SURROUND BACK/BI-AMP/FRONT HIGH/FRONT B terminals using a bi-amplifier connection.

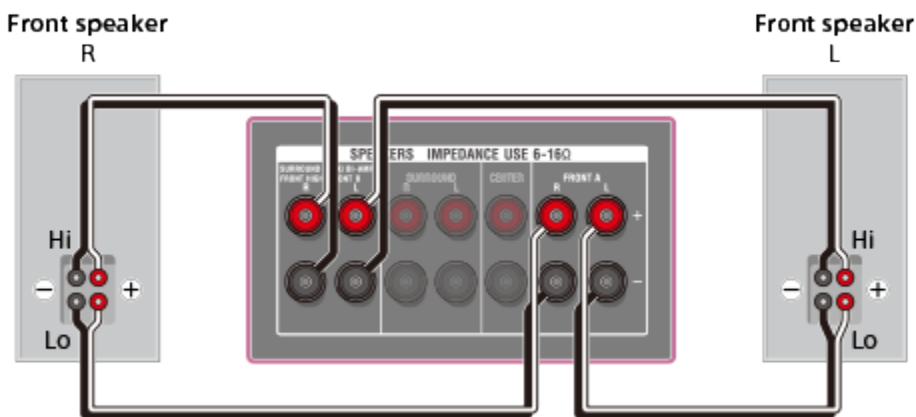

Connect the jacks on the Lo (or Hi) side of the front speakers to the SPEAKERS FRONT A terminals, and connect the jacks on the Hi (or Lo) side of the front speakers to the SPEAKERS SURROUND BACK/BI-AMP/FRONT HIGH/FRONT B terminals.

Make sure that metal fittings of Hi/Lo attached to the speakers have been removed from the speakers to avoid receiver malfunction.

After you have made the bi-amplifier connection, set [SB Assign] in the Speaker Settings menu to [Bi-Amp].

Related Topic

- [Notes on connecting cables](#)

Notes on use

4-488-933-11(1)

Copyright 2014 Sony Corporation



MULTI CHANNEL AV RECEIVER  
STR-DH750/STR-DH550

## Using the sleep timer

---

You can set the receiver to turn off automatically at a specified time.

1. Press SLEEP.

Each time you press SLEEP, the display changes cyclically as follows:

0-30-00 - 1-00-00 - 1-30-00 - 2-00-00 - OFF

[SLEEP] lights up on the display panel of the receiver when sleep timer is being used.

**Hint**

- To check the remaining time before the receiver turns off, press SLEEP. The remaining time appears on the display panel.
- The sleep timer will be canceled if you press  (on/standby).

### Notes on use

4-488-933-11(1)

Copyright 2014 Sony Corporation



MULTI CHANNEL AV RECEIVER  
STR-DH750/STR-DH550

## Viewing information on the display panel

---

The display panel provides various information on the status of the receiver, such as the sound field.

1. Select the input for which you want to check information.

2. Press DISPLAY repeatedly.

Each time you press DISPLAY, the display will change cyclically as follows:

Index name of the input (\*1) - Input you selected - Sound field currently applied (\*2) - Volume level - Stream information (\*3)

### **When listening to FM and AM radio**

Preset station name (\*1) - Frequency - Sound field currently applied (\*2) - Volume level

### **When receiving RDS broadcasts (for European and Australian models only)**

Program service name or preset station name (\*1) - Frequency, band and preset number - Sound field currently applied (\*2) - Volume level

\*1 Index name appears only when you have assigned one to the input or preset station. Index name does not appear if only blank spaces have been entered or it is same as the input name.

\*2 [PURE.DIRECT] appears on the display panel when the Pure Direct function is activated.

\*3 Stream information may not be displayed.

#### **Note**

- Characters or marks in some languages may not be displayed.

### [Notes on use](#)

4-488-933-11(1)

Copyright 2014 Sony Corporation



MULTI CHANNEL AV RECEIVER  
STR-DH750/STR-DH550

## Performing Auto Calibration

You can perform automatic calibration from where you are sitting.

1. Select [Settings] - [Speaker Settings] from the home menu.
2. Select [Auto Calibration].
3. Follow the instructions on the TV screen, then press **+** to select [Start].  
The measurement starts in 5 seconds.  
The measurement process will take approximately 30 seconds with a test tone.  
When the measurement ends, a beep sounds and the screen switches.
4. Select the item you want.
  - **Retry:** Performs the Auto Calibration again.
  - **Save&Exit:** Saves the measurement results and exits the setting process.
  - **WRN Check:** Displays warning related to the measurement results. See [“List of messages after Auto Calibration measurements.”](#)
  - **Exit:** Exits the setting process without saving the measurement results.

For details on the measurement results, see [“Checking Auto Calibration results.”](#)
5. Save the measurement results.  
Select [Save&Exit] in step 4.

**Note**

- If an error code or warning message appears on the screen in step 3, see [“List of messages after Auto Calibration measurements.”](#)
- This setting is not available when headphones are connected.

**Hint**

- The Auto Calibration function will be canceled if you perform the following during the measurement process:
  - Press **I/⏻**.
  - Press the input buttons on the remote control or turn the INPUT SELECTOR on the receiver.
  - Press **⊗**.
  - Press SPEAKERS on the receiver.
  - Change the volume level.
  - Connect headphones.

## Related Topic

- Before you perform Auto Calibration

- Checking Auto Calibration results

## Notes on use

4-488-933-11(1)

Copyright 2014 Sony Corporation



MULTI CHANNEL AV RECEIVER  
STR-DH750/STR-DH550

## Selecting the speaker pattern (Speaker Pattern)

---

You can select the speaker pattern according to the speaker system which you are using.

1. Select [Settings] - [Speaker Settings] from the home menu.
2. Select [Speaker Pattern].
3. Select the speaker pattern you want.

### Notes on use

4-488-933-11(1)

Copyright 2014 Sony Corporation



MULTI CHANNEL AV RECEIVER  
STR-DH750/STR-DH550

## Setting the assignment for the speaker terminals (SB Assign) (for STR-DH750 only)

---

You can select the speaker pattern and set the assignment for the SPEAKERS SURROUND BACK/BI-AMP/FRONT HIGH/FRONT B terminals.

1. Select [Settings] - [Speaker Settings] from the home menu.
2. Select [SB Assign].
3. Set the assignment for the SPEAKERS SURROUND BACK/BI-AMP/FRONT HIGH/FRONT B terminals.
  - **Speaker B:** Select if you connect an additional front speaker system to the SPEAKERS SURROUND BACK/BI-AMP/FRONT HIGH/ FRONT B terminals.
  - **Bi-Amp:** Select if you connect front speakers to the SPEAKERS SURROUND BACK/BI-AMP/FRONT HIGH/ FRONT B terminals using a bi-amplifier connection.
  - **Off:** Select if you connect surround back or front high speakers to the SPEAKERS SURROUND BACK/BI-AMP/FRONT HIGH/ FRONT B terminals.

### Note

- When you change the connection from a bi-amplifier or speakers front B to surround back or front high speakers connection, set the [SB Assign] to [Off], then set up the speakers again.
- You can only set the assignment for the SPEAKERS SURROUND BACK/BI-AMP/FRONT HIGH/FRONT B terminals if the speaker pattern is set to 2/0, 2/0.1, 3/0, 3/0.1, 2/2, 2/2.1, 3/2, or 3/2.1.

### Notes on use

4-488-933-11(1)

Copyright 2014 Sony Corporation



MULTI CHANNEL AV RECEIVER  
STR-DH750/STR-DH550

## Adjusting the speaker level (Manual Setup)

---

You can adjust the level of each speaker (front left/right, front high left/right (\*1), center, surround left/right, surround back left/right (\*1) and subwoofer).

\*1 for STR-DH750 only

1. Select [Settings] - [Speaker Settings] from the home menu.
2. Select [Manual Setup].
3. Select the speaker on the screen for which you want to adjust the speaker level.
4. Select [Level] and then press **↑** / **↓** to adjust the level.

### Note

- When one of the sound fields for music is selected, no sound is output from the subwoofer if all of the speakers are set to [Large] in the Speaker Settings menu. However, sound will be output from the subwoofer if:
  - \_ the digital input signal contains LFE signals.
  - \_ the front or surround speakers are set to [Small].
  - \_ [Multi Stereo], [PLII Movie], [PLII Music], [PLIIX Movie] (\*2), [PLIIX Music] (\*2), [HD-D.C.S.] or [Portable Audio] is selected.

\*2 for STR-DH750 only

### Notes on use

4-488-933-11(1)

Copyright 2014 Sony Corporation



MULTI CHANNEL AV RECEIVER  
STR-DH750/STR-DH550

## Adjusting the speaker size (Manual Setup)

---

You can adjust the size of each speaker (front left/right, front high left/right (\*1), center, surround left/right and surround back left/right (\*1)).

\*1 for STR-DH750 only

1. Select [Settings] - [Speaker Settings] from the home menu.
2. Select [Manual Setup].
3. Select the speaker on the screen for which you want to adjust the size.
4. Select [Size], then press **↑ / ↓** to adjust the size.
  - **Large:** If you connect large speakers that will effectively reproduce bass frequencies, select [Large]. Select [Large] usually.
  - **Small:** If the sound is distorted or you hear a lack of surround effects when using multi channel surround sound, select [Small]. You can activate the bass redirection circuitry and output the bass frequencies of each channel from the subwoofer or other [Large] speakers.

### Note

- This function does not work when [Analog Direct] is being used.

### Hint

- The [Large] and [Small] settings for each speaker determine whether the internal sound processor will cut the bass signal from that channel.  
When the bass is cut from a channel, the bass redirection circuitry sends the corresponding bass frequencies to the subwoofer or other [Large] speakers.  
However, since bass sound has a certain amount of directionality, it is best not to cut it if possible. Therefore, you can set even a small speaker to [Large] if you want to output the bass frequencies from that speaker. On the other hand, if you are using a large speaker but prefer not to output bass frequencies from that speaker, set it to [Small].  
If the overall sound level is lower than you prefer, set all speakers to [Large]. If there is not enough bass, you can use the equalizer to boost the bass levels.
- The surround back speakers will be set to the same setting as that of the surround speakers.
- When the front speakers are set to [Small], the center, surround, and surround back/front high (\*2) speakers are also automatically set to [Small].
- If you do not use the subwoofer, the front speakers are automatically set to [Large].
- [Size] cannot be set when headphones are connected.

\*2 for STR-DH750 only



MULTI CHANNEL AV RECEIVER  
STR-DH750/STR-DH550

## Adjusting the speaker distance (Manual Setup)

---

You can adjust the distance from where you are sitting to each speaker (front left/right, front high left/right (\*), center, surround left/right, surround back left/right (\*) and subwoofer).

\* for STR-DH750 only

1. Select [Settings] - [Speaker Settings] from the home menu.
2. Select [Manual Setup].
3. Select the speaker on the screen for which you want to adjust the distance from where you are sitting.
4. Select [Distance], then press **↑ / ↓** to adjust the distance.

### Note

- Some parameters may not be available depending on the speaker pattern setting.
- This function does not work when [Analog Direct] is being used.

### Hint

- When headphones are connected, [Distance] cannot be set.

### Notes on use

4-488-933-11(1)

Copyright 2014 Sony Corporation



MULTI CHANNEL AV RECEIVER  
STR-DH750/STR-DH550

## Setting the crossover frequency of the speakers (Crossover Freq.)

---

You can set the bass crossover frequency of speakers for which the speaker size has been set to [Small] in the Speaker Settings menu. A measured speaker crossover frequency is set for each speaker after the Auto Calibration is performed.

1. Select [Settings] - [Speaker Settings] from the home menu.
2. Select [Crossover Freq.].
3. Select the speaker parameter under the speaker for which you want to adjust the crossover frequency on the screen .
4. Press **↑ / ↓** to set the crossover frequency.

### Note

- This function does not work when headphones are connected.
- The surround back speakers will be set to the same setting as that of the surround speakers (for STR-DH750 only).

### Notes on use

4-488-933-11(1)

Copyright 2014 Sony Corporation





MULTI CHANNEL AV RECEIVER  
STR-DH750/STR-DH550

## Outputting a test tone from each speaker (Test Tone)

---

You can output a test tone from each speaker in sequence.

1. Select [Settings] - [Speaker Settings] from the home menu.
2. Select [Test Tone].
3. Select [Test Tone] again.
4. Select the setting you want.
  - **Off**
  - **Auto:** The test tone is output from each speaker in sequence.
5. Select the speaker on the screen for which you want to adjust the speaker level.
6. Adjust the speaker level.

### Hint

- To adjust the level of all speakers at the same time, press  $\triangle$  +/- . You can also use MASTER VOLUME on the receiver.
- The adjusted value is shown on the TV screen during adjustment.

### Notes on use

4-488-933-11(1)

Copyright 2014 Sony Corporation



MULTI CHANNEL AV RECEIVER  
STR-DH750/STR-DH550

## Selecting the unit of measurement (Distance Unit)

---

You can select the unit of measurement for setting distances.

1. Select [Settings] - [Speaker Settings] from the home menu.
2. Select [Distance Unit].
3. Select the setting you want.
  - **feet:** The distance is displayed in feet.
  - **meter:** The distance is displayed in meters.

### Notes on use

4-488-933-11(1)

Copyright 2014 Sony Corporation



MULTI CHANNEL AV RECEIVER  
STR-DH750/STR-DH550

## Synchronizing audio with video output (A/V Sync.)

---

You can delay the output of audio to minimize the time gap between audio output and a visual display. This function is useful when using a large LCD or plasma monitor or a projector. You can set the function for each input independently.

1. Select [Settings] - [Audio Settings] from the home menu.
2. Select [A/V Sync.].
3. Select the setting you want.
  - **On (Delay time: 60ms):** The audio output is delayed so that the time gap between the audio output and visual display is minimized.
  - **Off (Delay time: 0ms):** The audio output is not delayed.

### Note

- The receiver may play signals at a lower sampling frequency than the actual sampling frequency of the input signals, depending on the audio format.

### Notes on use

4-488-933-11(1)

Copyright 2014 Sony Corporation



MULTI CHANNEL AV RECEIVER  
STR-DH750/STR-DH550

## Adjusting the volume automatically (Auto Volume)

---

This receiver can adjust its volume automatically depending on the input signal or content from a connected device.

This function is useful, for example, when the sound of commercials is louder than a TV program.

1. Select [Settings] - [Audio Settings] from the home menu.
2. Select [Auto Volume].
3. Set to [On] or [Off].

### Note

- Be sure to reduce the volume level before you turn this function on or off.
- The Auto Volume function may not work, depending on the audio format.
- This function does not work when [Analog Direct] is being used.

### Notes on use

4-488-933-11(1)

Copyright 2014 Sony Corporation



MULTI CHANNEL AV RECEIVER  
STR-DH750/STR-DH550

## Selecting the language of digital broadcasts (Dual Mono)

---

You can select the language you want when listening to a digital broadcast with dual audio. This function only works for Dolby Digital sources.

1. Select [Settings] - [Audio Settings] from the home menu.
2. Select [Dual Mono].
3. Select the setting you want.
  - **Main/Sub:** Sound in the main language will be output through the front left speaker and sound in the sub language will be output through the front right speaker simultaneously.
  - **Main:** Sound in the main language will be output.
  - **Sub:** Sound in the sub language will be output.

### Notes on use

4-488-933-11(1)

Copyright 2014 Sony Corporation



MULTI CHANNEL AV RECEIVER  
STR-DH750/STR-DH550

## Compressing the dynamic range (D.Range Comp.)

---

You can compress the dynamic range of the soundtrack. This may be useful when you want to watch movies at a low volume late at night, etc.

This function only works for Dolby Digital and Dolby TrueHD sources.

1. Select [Settings] - [Audio Settings] from the home menu.
2. Select [D.Range Comp.].
3. Select the setting you want.
  - **On:** The dynamic range is compressed as intended by the recording engineer.
  - **Auto:** The dynamic range is compressed automatically when there is a flag in the sound source that recommends using the D.Range Comp. function.
  - **Off**

### Notes on use

4-488-933-11(1)

Copyright 2014 Sony Corporation



MULTI CHANNEL AV RECEIVER  
STR-DH750/STR-DH550

## Controlling HDMI devices (Control for HDMI)

---

You can turn the Control for HDMI function on or off. For details, see “[Preparing for “BRAVIA” Sync.](#)”

1. Select [Settings] - [HDMI Settings] from the home menu.
2. Select [Control for HDMI].
3. Set to [On] or [Off].

### Note

- When you set [Control for HDMI] to [On], [HDMI Audio Out] may be changed automatically.
- When the receiver is in standby mode, the  $\text{I/O}$  (on/standby) indicator on the front panel lights up in amber if [Control for HDMI] is set to [On].

### Related Topic

- [Preparing for “BRAVIA” Sync](#)

### Notes on use

4-488-933-11(1)

Copyright 2014 Sony Corporation



MULTI CHANNEL AV RECEIVER  
STR-DH750/STR-DH550

## Passing HDMI signals through (Pass Through)

---

You can output HDMI signals to the TV even when the receiver is in standby mode.

1. Select [Settings] - [HDMI Settings] from the home menu.
2. Select [Pass Through].
3. Select the setting you want.
  - **On** (\*): The receiver continuously outputs HDMI signals from the HDMI TV OUT jack when in standby mode.
  - **Auto**: The receiver outputs HDMI signals to the TV from the HDMI TV OUT jack when the TV is turned on while the receiver is in the standby mode.  
Sony recommends this setting if you are using a “BRAVIA” Sync-compatible Sony TV. This setting saves power in the standby mode compared to the [On] setting.
  - **Off**: The receiver does not output HDMI signals when in standby mode.  
This setting saves power in the standby mode compared to the [On] setting.

\* For USA, Canadian, and Australian models only

### Note

- [Auto] can only work when [Control for HDMI] is set to [On].
- When the receiver is in standby mode, the I/⏻ (on/standby) indicator on the front panel lights up in amber if [Pass Through] is set to [On] or [Auto].
- When [Auto] is selected, it may take a little more time for the image and sound to be output to the TV than when [On] is selected.

### Notes on use

4-488-933-11(1)

Copyright 2014 Sony Corporation





MULTI CHANNEL AV RECEIVER  
STR-DH750/STR-DH550

## Setting the HDMI audio signal output of connected devices (HDMI Audio Out)

---

You can set the HDMI audio signal output of playback devices connected to the receiver via an HDMI connection.

1. Select [Settings] - [HDMI Settings] from the home menu.
2. Select [HDMI Audio Out].
3. Select the setting you want.
  - **AMP**: HDMI audio signals from playback devices are only output to the speakers connected to the receiver. Multi-channel sound can be played back as it is.
  - **TV+AMP**: The sound is output from the speaker of the TV and the speakers connected to the receiver.

### Note

- Audio signals are not output from the speaker of the TV when [HDMI Audio Out] is set to [AMP].
- The sound quality of the playback equipment depends on the sound quality of the TV, such as the number of channels and the sampling frequency, etc. If the TV has stereo speakers, the sound output from the receiver is in the same stereo as the TV, even when playing back multi-channel source.
- When you connect the receiver to a video device (projector, etc.), sound may not be output from the receiver. In this case, select [AMP].

### Notes on use

4-488-933-11(1)

Copyright 2014 Sony Corporation



MULTI CHANNEL AV RECEIVER  
STR-DH750/STR-DH550

## Setting the level of the subwoofer (Subwoofer Level)

---

You can set the level of the subwoofer to 0 dB or +10 dB when PCM signals are input via an HDMI connection. The level for each input to which an HDMI input jack is assigned can be set independently.

1. Select [Settings] - [HDMI Settings] from the home menu.
2. Select [Subwoofer Level].
3. Select the setting you want.
  - **Auto:** Automatically sets the level to 0 dB or +10 dB, depending on the audio stream.
  - **+10 dB**
  - **0 dB**

### Note

- This setting is invalid when [FM], [AM], [USB], or [BLUETOOTH] (\*) is selected.

\* For STR-DH750 only

### Notes on use

4-488-933-11(1)

Copyright 2014 Sony Corporation



MULTI CHANNEL AV RECEIVER  
STR-DH750/STR-DH550

## Speeding up the display when switching the HDMI input (Fast View)

---

You can set the Fast View function for the HDMI inputs.

1. Select [Settings] - [HDMI Settings] from the home menu.
2. Select [Fast View].
3. Select the setting you want.
  - **Auto:** You can select HDMI input faster than normal selection.
  - **Off:** The Fast View function is not available.

### Notes on use

4-488-933-11(1)

Copyright 2014 Sony Corporation



MULTI CHANNEL AV RECEIVER  
STR-DH750/STR-DH550

### Automatically switching the input when an MHL device is played (MHL Auto Input)

---

This allows you to turn the function that automatically switches input to the MHL device input on or off when the MHL device is played.

1. Select [Settings] - [HDMI Settings] from the home menu.
2. Select [MHL Auto Input].
3. Select [On] or [Off].

#### Notes on use

4-488-933-11(1)

Copyright 2014 Sony Corporation



MULTI CHANNEL AV RECEIVER  
STR-DH750/STR-DH550

## Changing the assignment and display for the input jacks

---

You can customize the settings for each input according to your preferences and usage. Select [Settings] - [Input Settings] from the home menu, then set each item shown below.

### Input Mode

You can fix the audio input mode when you connect device to both digital and analog audio input jacks. For details, see “[Switching between digital and analog audio \(Input Mode\)](#).”

### Input Edit

You can set whether an input is displayed on the Watch menu or the Listen menu.

- **Watch:** Displays an input to the Watch menu.
- **Listen:** Displays an input to the Listen menu.
- **Watch+Listen:** Displays an input to both the Watch and Listen menus.

### Audio Input Assign

You can set the audio input jack(s) assigned to each input. For details, see “[Using other video/audio input jacks \(Audio Input Assign\)](#).”

### Name In

You can change the name displayed on the Watch/Listen menu. For details on how to set the name for each input, see “[Changing the name for each input \(Name In\)](#).”

### Notes on use

4-488-933-11(1)

Copyright 2014 Sony Corporation



MULTI CHANNEL AV RECEIVER  
STR-DH750/STR-DH550

## Changing the name for each input (Name In)

---

You can enter up to 8 characters for each input name.

1. Select [Settings] - [Input Settings] from the home menu.
2. Select the input name you want to change.
3. Select [Name In].
4. Press  $\uparrow$  /  $\downarrow$  repeatedly to select a character, then press  $\rightarrow$ .  
You can move the input position backward and forward by pressing  $\leftarrow$  /  $\rightarrow$ .
5. Repeat step 4 to input characters one by one, then press  $\oplus$ .  
The name you entered is registered.

### Notes on use

4-488-933-11(1)

Copyright 2014 Sony Corporation



MULTI CHANNEL AV RECEIVER  
STR-DH750/STR-DH550

## Selecting the language (Language)

---

You can select the language of messages on the screen.

1. Select [Settings] - [System Settings] from the home menu.
2. Select [Language].
3. Select the language you want.

### Notes on use

4-488-933-11(1)

Copyright 2014 Sony Corporation



MULTI CHANNEL AV RECEIVER  
STR-DH750/STR-DH550

## Setting standby mode (Auto Standby)

---

You can set the receiver to switch to standby mode automatically when you do not operate the receiver or when no signals are input to the receiver.

1. Select [Settings] - [System Settings] from the home menu.
2. Select [Auto Standby].
3. Set [On] or [Off].

When you set [On], the receiver switches to standby mode after approximately 20 minutes.

### Note

- This function does not work when [FM] or [AM] is selected as the input.
- If you use the Auto Standby mode and the sleep timer at the same time, the sleep timer has priority.

### Notes on use

4-488-933-11(1)

Copyright 2014 Sony Corporation



MULTI CHANNEL AV RECEIVER  
STR-DH750/STR-DH550

## Operating the receiver with the menu on the display panel

You can operate this receiver using the display panel even if the TV is not connected to the receiver.

1. Press AMP MENU.  
The menu is displayed on the display panel of the receiver.
2. Press **↑ / ↓** repeatedly to select the menu you want, then press **+**.
3. Press **↑ / ↓** repeatedly to select the parameter you want to adjust, then press **+**.
4. Press **↑ / ↓** repeatedly to select the setting you want, then press **+**.

**To return to the previous display**

Press **←** or RETURN.

**To exit the menu**

Press AMP MENU.

**Note**

- Some parameters and settings may appear dimmed on the display panel. This means that they are either unavailable or fixed and unchangeable.

## Related Topic

- [Menu list \(on the display panel\)](#)

## Notes on use

4-488-933-11(1)

Copyright 2014 Sony Corporation



MULTI CHANNEL AV RECEIVER  
STR-DH750/STR-DH550

## Reverting to the factory default settings

---

You can clear all memorized settings and restore the receiver to the factory default settings by the following procedure. This procedure can also be used to initialize the receiver before you use it for the first time. Be sure to use the buttons on the receiver to perform this operation.

1. Turn off the receiver.
2. Hold down  $I/\text{ON}$  (on/standby) on the receiver for 5 seconds.  
[CLEARING] appears on the display panel for a while, then changes to [CLEARED \*].

### Note

- It takes a few minutes for the memory to be cleared completely. Do not turn the receiver off until [CLEARED \*] appears on the display panel.

### Notes on use

4-488-933-11(1)

Copyright 2014 Sony Corporation



MULTI CHANNEL AV RECEIVER  
STR-DH750/STR-DH550

Front panel (STR-DH750)

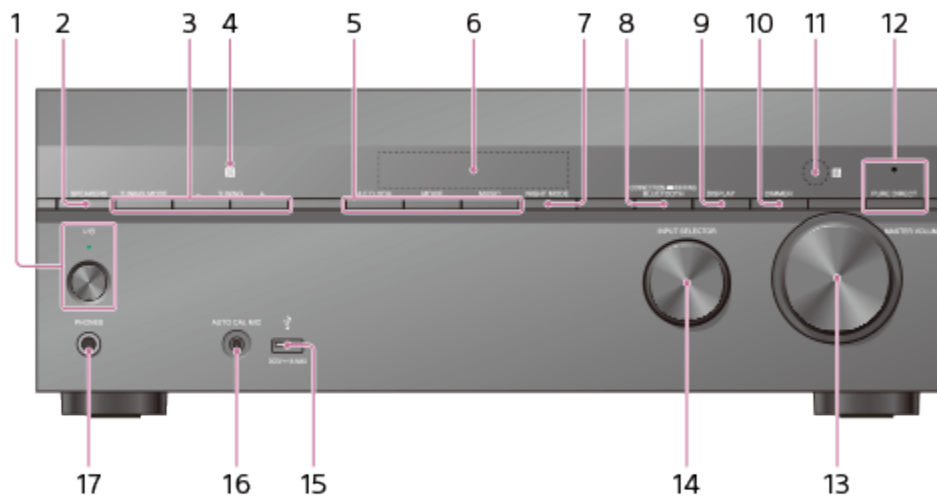

1. **I/O (on/standby)**
2. **SPEAKERS**
3. **TUNING MODE, TUNING +/-**  
Press to operate a tuner (FM/AM).  
Press TUNING +/- to scan a station.
4. **NFC sensor**
5. **A.F.D./2CH, MOVIE, MUSIC**
6. **Display panel**
7. **NIGHT MODE**
8. **CONNECTION PAIRING BLUETOOTH**  
Operates the BLUETOOTH function.
9. **DISPLAY**
10. **DIMMER**  
Adjusts the brightness of the display panel in 3 levels.
11. **Remote control sensor**  
Receives signals from remote control.
12. **PURE DIRECT**  
The indicator above the button lights up when the Pure Direct function is activated.
13. **MASTER VOLUME**
14. **INPUT SELECTOR**
15. **ψ (USB) port**
16. **AUTO CAL MIC jack**
17. **PHONES jack**  
Connect headphones here.

## Indicator light above I/O (on/standby) button (1)

- Green: The receiver is turned on.
- Amber: The receiver is in standby mode, and:
  - [Control for HDMI] or [Bluetooth Standby] is set to [On].
  - [Pass Through] is set to [On] (\*) or [Auto].

Indicator turns off when the receiver is in standby mode and [Control for HDMI], [Pass Through], and [Bluetooth Standby] are set to [Off].

\* For USA, Canadian, and Australian models only

### Notes on use

4-488-933-11(1)

Copyright 2014 Sony Corporation



MULTI CHANNEL AV RECEIVER  
STR-DH750/STR-DH550

Front panel (STR-DH550)

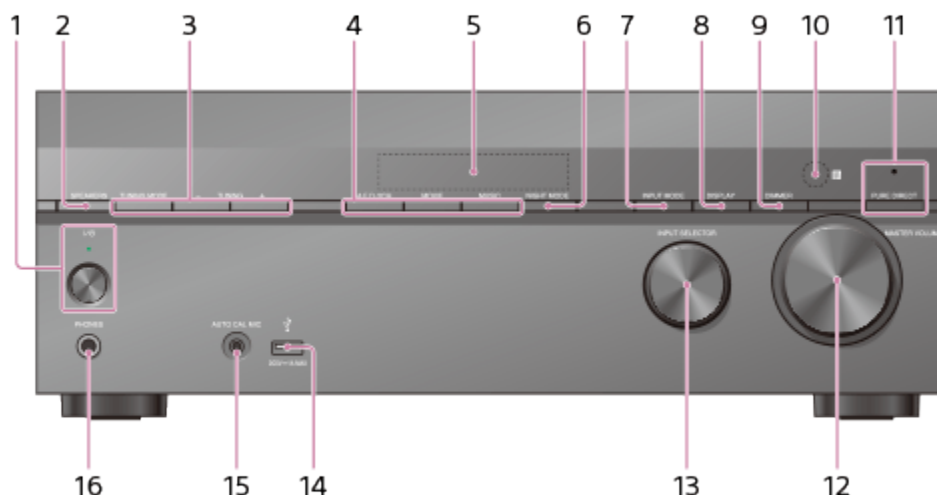

1. **I/⏻ (on/standby)**
2. **SPEAKERS**  
Press repeatedly to turn on or off the speaker system.
3. **TUNING MODE, TUNING +/-**  
Press to operate a tuner (FM/AM).  
Press TUNING +/- to scan a station.
4. **A.F.D./2CH, MOVIE, MUSIC**
5. **Display panel**
6. **NIGHT MODE**
7. **INPUT MODE**
8. **DISPLAY**
9. **DIMMER**  
Adjusts the brightness of the display panel in 3 levels.
10. **Remote control sensor**  
Receives signals from remote control.
11. **PURE DIRECT**  
The indicator above the button lights up when the Pure Direct function is activated.
12. **MASTER VOLUME**
13. **INPUT SELECTOR**
14. **ψ (USB) port**
15. **AUTO CAL MIC jack**
16. **PHONES jack**  
Connect headphones here.

- Green: The receiver is turned on.
- Amber: The receiver is in standby mode, and:
  - [Control for HDMI] is set to [On].
  - [Pass Through] is set to [On] (\*) or [Auto].

Indicator turns off when the receiver is in standby mode and [Control for HDMI], and [Pass Through] are set to [Off].

\* For USA, Canadian, and Australian models only

### Notes on use

4-488-933-11(1)

Copyright 2014 Sony Corporation



MULTI CHANNEL AV RECEIVER  
STR-DH750/STR-DH550

Rear panel (STR-DH750)

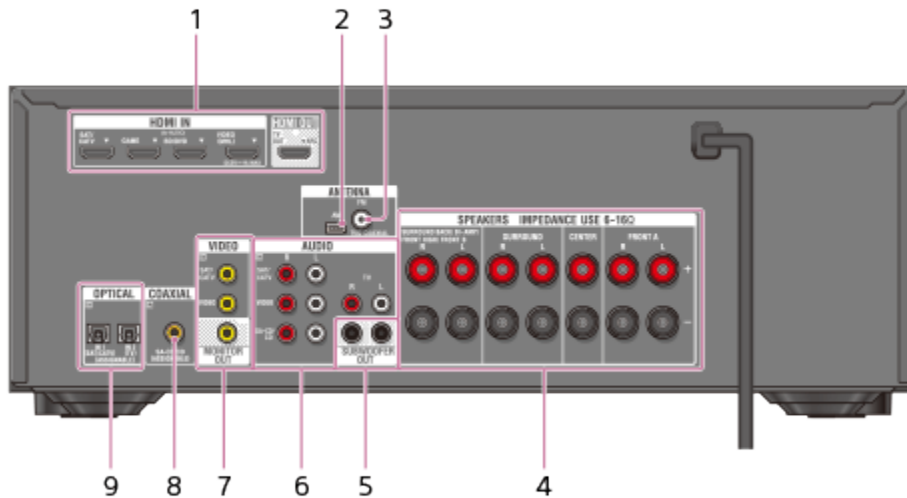

1. **HDMI IN/OUT (\*) jacks**
2. **AM ANTENNA terminal**
3. **FM ANTENNA terminal**
4. **SPEAKERS terminals**
5. **SUBWOOFER OUT jacks**
6. **AUDIO IN jacks**
7. **VIDEO IN/OUT (\*) jacks**
8. **COAXIAL IN jack**
9. **OPTICAL IN jacks**

\* You must connect your TV to MONITOR OUT to watch images from the selected input.

[Notes on use](#)

4-488-933-11(1)

Copyright 2014 Sony Corporation



MULTI CHANNEL AV RECEIVER  
STR-DH750/STR-DH550

Rear panel (STR-DH550)

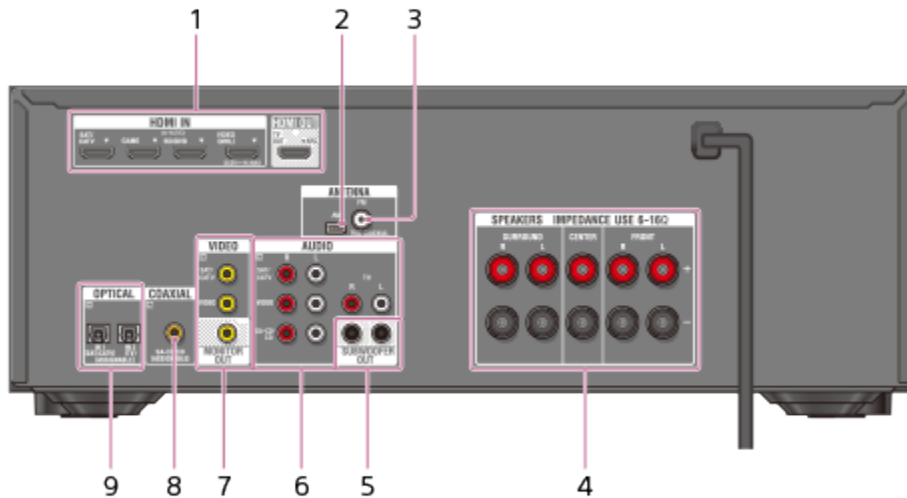

1. **HDMI IN/OUT (\*) jacks**
2. **AM ANTENNA terminal**
3. **FM ANTENNA terminal**
4. **SPEAKERS terminals**
5. **SUBWOOFER OUT jacks**
6. **AUDIO IN jacks**
7. **VIDEO IN/OUT (\*) jacks**
8. **COAXIAL IN jack**
9. **OPTICAL IN jacks**

\* You must connect your TV to MONITOR OUT to watch images from the selected input.

Notes on use

4-488-933-11(1)

Copyright 2014 Sony Corporation





MULTI CHANNEL AV RECEIVER  
STR-DH750/STR-DH550

### Indicators on the display panel

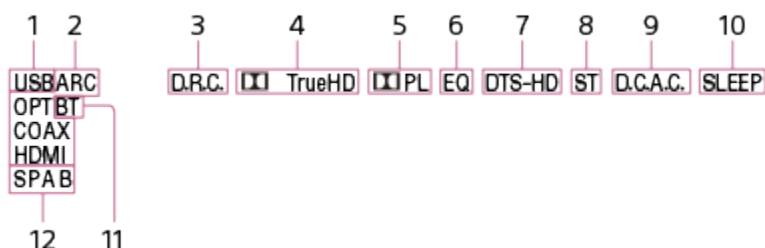

1. **USB**  
Lights up when an iPhone/iPod or USB device is detected.
2. **Input indicator**  
Lights up to indicate the current input.
  - HDMI**  
The receiver recognizes devices connected via an HDMI IN jack.
  - ARC**  
TV input is selected and Audio Return Channel (ARC) signals are detected.
  - COAX**  
Digital signals are input through the COAXIAL jack.
  - OPT**  
Digital signals are input through the OPTICAL jack.
3. **D.R.C.**  
Lights up when dynamic range compression is activated.
4. **Dolby Digital Surround indicator (\*1)**  
The applicable indicator lights up when the receiver is decoding the corresponding Dolby Digital format signals.
  -  **TrueHD**: Dolby TrueHD
5. **Dolby Pro Logic indicator**  
The applicable indicator lights up when the receiver performs Dolby Pro Logic processing (Dolby Pro Logic). This matrix surround decoding technology can enhance input signals.
6. **EQ**  
Lights up when the equalizer is activated.
7. **DTS(-HD) indicator (\*1)**  
The applicable indicator lights up when the receiver is decoding the corresponding DTS format signals.
  - DTS-HD**: DTS-HD
8. **ST**  
Lights up when the receiver tunes to a stereo broadcast.
9. **D.C.A.C.**  
Lights up when the measurement results of the Auto Calibration function are applied.
10. **SLEEP**

Lights up when the sleep timer is activated.

11. **BT** (\*2)

Lights up when a BLUETOOTH device is connected. Flashes during pairing.

12. **Speaker system indicator**

\*1 When playing a Dolby Digital or DTS format disc, make sure that you have completed the digital connections, that [Input Mode] is not set to [Analog], and [Analog Direct] is not selected.

\*2 for STR-DH750 only

**Note**

- The Dolby Pro Logic indicator (5) may not light up depending on the speaker pattern setting.

Notes on use

4-488-933-11(1)

Copyright 2014 Sony Corporation



MULTI CHANNEL AV RECEIVER  
STR-DH750/STR-DH550

Remote control

Use the supplied remote control to operate this receiver.

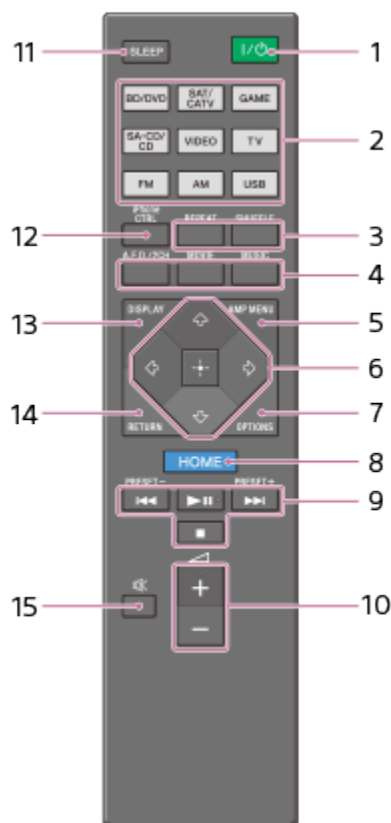

1. **I/O (on/standby)**

Turns the receiver on or sets it to the standby mode.

**Saving power in standby mode**

Save power by setting [Control for HDMI], [Pass Through], and [Bluetooth Standby] (for STR-DH750 only) to [Off].

2. **Input buttons**

Select the device you want to use.

When you press any of the input buttons, the receiver turns on. The input buttons are pre-assigned to automatically control Sony devices when you select them.

3. **REPEAT**

Plays a track or a folder repeatedly.

**SHUFFLE**





Plays a track or a folder in random order.

4. **A.F.D./2CH, MOVIE, MUSIC**

Select a sound field.

5. **AMP MENU**

Displays the menu to operate the receiver.

6. ,  /  /  / 

7. **OPTIONS**

Display and select items from the options menus.

8. **HOME**

Displays the menu of the audio/video device that is currently being controlled by the remote control.

9.  /  / ,  ( \* ), 

Skip, play, pause, stop operation.

**PRESET+/-**

Select preset stations or channels.

10.  + ( \* ) / -

Adjust the volume level of all speakers at the same time.

11. **SLEEP**

12. **iPhone CTRL**

Enter iPhone/iPod control mode when using iPhone/iPod.

13. **DISPLAY**



View information on the display panel.

14. **RETURN**

Returns to the previous menu or exits menu or on-screen guide that is displayed on the TV screen.

15. 

Turns off the sound temporarily. Press the button again to restore the sound.

\* The  and  + buttons have tactile dots. Use the tactile dots as a reference when operating the receiver.

**Note**

- The above explanations are intended to serve as examples.
- Depending on the model of your connected device, some functions explained in this section may not work with the supplied remote control.

[Notes on use](#)

4-488-933-11(1)

Copyright 2014 Sony Corporation



MULTI CHANNEL AV RECEIVER  
STR-DH750/STR-DH550

## Specifications

---

### **POWER OUTPUT AND TOTAL HARMONIC DISTORTION: (USA model only)**

With 6 ohm loads, both channels driven, from 20 – 20,000 Hz; rated 90 watts per channel minimum RMS power, with no more than 0.09% total harmonic distortion from 250 milliwatts to rated output.

#### **Amplifier section**

Minimum RMS Output Power (\*1): 90 W + 90 W (6 ohms, 20 Hz – 20 kHz, THD 0.09%)

Stereo Mode Output Power (\*1): 105 W + 105 W (6 ohms, 1 kHz, THD 1%)

Surround Mode Output Power (\*1)(\*2): 145 W per channel (6 ohms, 1 kHz, THD 0.9%)

\*1 Measured under the following conditions (Area: Power requirements):

USA and Canadian models: 120 V AC, 60 Hz

European and Australian model: 230 V AC, 50 Hz

\*2 Reference power output for front, center, surround, surround back (for STR-DH750 only) and front high (for STR-DH750 only) speakers. Depending on the sound field settings and the source, there may be no sound output.

#### **Frequency response**

##### **Analog:**

10 Hz – 100 kHz, +0.5/–2 dB (with sound field and equalizer bypassed)

#### **Input**

##### **Analog:**

Sensitivity: 500 mV/50 kilohms

S/N (\*3): 105 dB (A, 500 mV (\*4))

##### **Digital (Coaxial):**

Impedance: 75 ohms

S/N: 100 dB (A, 20 kHz LPF)

##### **Digital (Optical):**

S/N: 100 dB (A, 20 kHz LPF)

#### **Output (Analog)**

##### **SUBWOOFER:**

Voltage: 2 V/1 kilohm

#### **Equalizer**

##### **Gain levels:**

±10 dB, 1 dB step

\*3 INPUT SHORT (with sound field and equalizer bypassed).

\*4 Weighted network, input level.

## **FM tuner section**

Tuning range: 87.5 MHz – 108.0 MHz

Antenna (aerial): FM wire antenna (aerial)

Antenna (aerial) terminals: 75 ohms, unbalanced

## **AM tuner section**

### **Tuning range (USA and Canada):**

530 kHz – 1,710 kHz (Tuning scale: 10 kHz step)

531 kHz – 1,710 kHz (Tuning scale: 9 kHz step)

### **Tuning range (Europe and Australia):**

531 kHz – 1,602 kHz (Tuning scale: 9 kHz step)

Antenna (aerial): Loop antenna (aerial)

## **Video section**

### **Inputs/Outputs**

#### **Video:**

1 V<sub>p-p</sub>, 75 ohms

## **HDMI Video**

### **Input/Output (HDMI Repeater block)**

#### **4096 × 2160p @ 59.94/60 Hz:**

2D (\*1)

#### **4096 × 2160p @ 50 Hz:**

2D (\*1)

#### **3840 × 2160p @ 59.94/60 Hz:**

2D (\*1)

#### **3840 × 2160p @ 50 Hz:**

2D (\*1)

#### **4096 × 2160p @ 23.98/24 Hz:**

2D (\*2)

#### **3840 × 2160p @ 29.97/30 Hz:**

2D (\*2)

#### **3840 × 2160p @ 25 Hz:**

2D (\*2)

#### **3840 × 2160p @ 23.98/24 Hz:**

2D (\*2)

#### **1920 × 1080p @ 59.94/60 Hz:**

2D

3D: Side-by-Side (Half)

3D: Over-Under (Top-and-Bottom)

**1920 × 1080p @ 50 Hz:**

2D

3D: Side-by-Side (Half)

3D: Over-Under (Top-and-Bottom)

**1920 × 1080p @ 29.97/30 Hz:**

2D (\*3)

3D: Frame packing

3D: Side-by-Side (Half) (\*3)

3D: Over-Under (Top-and-Bottom) (\*3)

**1920 × 1080p @ 25 Hz:**

2D (\*3)

3D: Frame packing

3D: Side-by-Side (Half) (\*3)

3D: Over-Under (Top-and-Bottom) (\*3)

**1920 × 1080p @ 23.98/24 Hz:**

2D (\*3)

3D: Frame packing

3D: Side-by-Side (Half) (\*3)

3D: Over-Under (Top-and-Bottom) (\*3)

**1920 × 1080i @ 59.94/60 Hz:**

2D (\*3)

3D: Frame packing

3D: Side-by-Side (Half) (\*3)

3D: Over-Under (Top-and-Bottom) (\*3)

**1920 × 1080i @ 50 Hz:**

2D (\*3)

3D: Frame packing

3D: Side-by-Side (Half) (\*3)

3D: Over-Under (Top-and-Bottom) (\*3)

**1280 × 720p @ 59.94/60 Hz:**

2D (\*3)

3D: Frame packing

3D: Side-by-Side (Half) (\*3)

3D: Over-Under (Top-and-Bottom) (\*3)

**1280 × 720p @ 50 Hz:**

2D (\*3)

3D: Frame packing

3D: Side-by-Side (Half) (\*3)

3D: Over-Under (Top-and-Bottom) (\*3)

**1280 x 720p @ 29.97/30 Hz:**

2D (\*3)

3D: Frame packing

3D: Side-by-Side (Half) (\*3)

3D: Over-Under (Top-and-Bottom) (\*3)

**1280 x 720p @ 23.98/24 Hz:**

2D (\*3)

3D: Frame packing

3D: Side-by-Side (Half) (\*3)

3D: Over-Under (Top-and-Bottom) (\*3)

**720 x 480p @ 59.94/60 Hz:**

2D (\*3)

**720 x 576p @ 50 Hz:**

2D (\*3)

**640 x 480p @ 59.94/60 Hz:**

2D (\*3)

\*1 Supports YUV 4:2:0 / 8 bit format only.

\*2 Supports 8 bit format only.

\*3 These formats are also supported by MHL connection.

**MHL section**

Supported MHL version: Incorporates MHL 2

Maximum current: 900 mA

**iPhone/iPod section**

DC 5V 1.0 A MAX

USB works with iPhone 5s, iPhone 5c, iPhone 5, iPhone 4s, iPhone 4, iPhone 3GS, iPhone 3G, iPod touch (2nd through 5th generation), iPod classic, and iPod nano (3rd through 7th generation).

BLUETOOTH technology works with iPhone 5s, iPhone 5c, iPhone 5, iPhone 4s, iPhone 4, iPhone 3GS, and iPod touch (4th and 5th generation) (\*).

You can use “SongPal” app with this receiver via BLUETOOTH (\*).

\* For STR-DH750 only

**BLUETOOTH section (for STR-DH750 only)**

Communication system: BLUETOOTH Specification version 3.0

Output: BLUETOOTH Specification Power Class 2

Maximum communication range: Line of sight approx. 10 m (33 feet) (\*1)

Frequency band: 2.4 GHz band (2.4000 GHz – 2.4835 GHz)

Modulation method: FHSS (Freq Hopping Spread Spectrum)

Compatible BLUETOOTH profiles (\*2): A2DP (Advanced Audio Distribution Profile), AVRCP 1.3 (Audio Video Remote Control Profile)

Supported Codecs (\*3): SBC (\*4), AAC, aptX

Transmission range (A2DP): 20 Hz – 20,000 Hz (Sampling frequency 44.1 kHz)



microwave oven, static electricity, cordless phone, reception sensitivity, antenna's performance, operating system, software application, etc.

\*2 BLUETOOTH standard profiles indicate the purpose of BLUETOOTH communication between devices.

\*3 Codec: Audio signal compression and conversion format

\*4 Subband Codec

## General section

### Power requirements

USA and Canadian models: 120 V AC, 60 Hz

European model: 230 V AC, 50/60 Hz

Australian model: 230 V AC, 50 Hz

### Power consumption

STR-DH750: 240 W

STR-DH550: 200 W

### Power consumption (during standby mode)

#### STR-DH750:

0.3 W (When [Control for HDMI], [Pass Through], and [Bluetooth Standby] are set to [Off].)

0.5 W (When [Control for HDMI] and [Bluetooth Standby] are set to [On], and [Pass Through] is set to [Off].)

#### STR-DH550:

0.3 W (When [Control for HDMI] and [Pass Through] are set to [Off].)

0.5 W (When [Control for HDMI] is set to [On], and [Pass Through] is set to [Off].)

### Dimensions (width/height/depth) (Approx.)

430 mm × 156 mm × 329.4 mm (17 in × 6 1/4 in × 13 in)

including projecting parts and controls

### Mass (Approx.)

7.6 kg (16 lb 13 oz)

Design and specifications are subject to change without notice.

#### Related Topic

● [Compatible USB devices and USB specifications](#)

● [Compatible iPhone/iPod models](#)

#### Notes on use

4-488-933-11(1)

Copyright 2014 Sony Corporation



MULTI CHANNEL AV RECEIVER  
STR-DH750/STR-DH550

## Trademarks

---

- This receiver incorporates Dolby (\*) Digital and Pro Logic Surround and the DTS (\*\*) Digital Surround System.

### For STR-DH750 only

\* Manufactured under license from Dolby Laboratories. Dolby, Pro Logic, Surround EX, and the double-D symbol are trademarks of Dolby Laboratories.

\*\* For DTS patents, see <http://patents.dts.com>. Manufactured under license from DTS Licensing Limited. DTS, DTS-HD, the Symbol, & DTS and the Symbol together are registered trademarks, and DTS-HD Master Audio is a trademark of DTS, Inc. © DTS, Inc. All Rights Reserved.

### For STR-DH550 only

\* Manufactured under license from Dolby Laboratories. Dolby, Pro Logic, and the double-D symbol are trademarks of Dolby Laboratories.

\*\* For DTS patents, see <http://patents.dts.com>. Manufactured under license from DTS Licensing Limited. DTS, DTS-HD, the Symbol, & DTS and the Symbol together are registered trademarks of DTS, Inc. © DTS, Inc. All Rights Reserved.

- This receiver incorporates High-Definition Multimedia Interface (HDMI™) technology. The terms HDMI and HDMI High-Definition Multimedia Interface, and the HDMI Logo are trademarks or registered trademarks of HDMI Licensing LLC in the United States and other countries.
- iPhone, iPod, iPod classic, iPod nano, and iPod touch are trademarks of Apple Inc., registered in the U.S. and other countries.  
App Store is a service mark of Apple Inc. (for STR-DH750 only).
- All other trademarks and registered trademarks are of their respective holders. In this manual, ™ and ® marks are not specified.
- “Made for iPod” and “Made for iPhone” mean that an electronic accessory has been designed to connect specifically to iPod or iPhone respectively, and has been certified by the developer to meet Apple performance standards.  
Apple is not responsible for the operation of this device or its compliance with safety and regulatory standards. Please note that the use of this accessory with iPod or iPhone may affect wireless performance.
- Windows Media is either registered trademarks or trademarks of Microsoft Corporation in the United States and/or other countries.
- This product is protected by certain intellectual property rights of Microsoft Corporation. Use or distribution of such technology outside of this product is prohibited without a license from Microsoft or an authorized Microsoft subsidiary.
- MPEG Layer-3 audio coding technology and patents licensed from Fraunhofer IIS and Thomson.
- “x.v.Color (x.v.Colour)” and “x.v.Color (x.v.Colour)” logo are trademarks of Sony Corporation.
- “BRAVIA” is a trademark of Sony Corporation.
- “PlayStation” is a registered trademark of Sony Computer Entertainment Inc.
- “WALKMAN” and “WALKMAN” logo are registered trademarks of Sony Corporation.
- MICROVAULT is a trademark of Sony Corporation.
- MHL, Mobile High-Definition Link and the MHL Logo are trademarks or registered trademarks of MHL Licensing, LLC.

## For STR-DH750 only

- The BLUETOOTH® word mark and logos are registered trademarks owned by Bluetooth SIG, Inc. and any use of such marks by Sony Corporation is under license. Other trademarks and trade names are those of their respective owners.
- © 2013 CSR plc and its group companies. The aptX® mark and the aptX logo are trade marks of CSR plc or one of its group companies and may be registered in one or more jurisdictions.
- The N Mark is a trademark or registered trademark of NFC Forum, Inc. in the United States and in other countries.
- Android™ is a trademark of Google Inc.
- Google Play™ is a trademark of Google Inc.

### Notes on use

4-488-933-11(1)

Copyright 2014 Sony Corporation



MULTI CHANNEL AV RECEIVER  
STR-DH750/STR-DH550

## PROTECTOR

---

The receiver will automatically turn off after a few seconds. Check the followings:

- There may be an electrical surge or power failure. Unplug the AC power cord (mains lead) and then plug in the cord again after 30 minutes.
- The receiver is covered and the ventilation holes are blocked. Remove the object covering the ventilation holes of the receiver.
- The impedance of the connected speakers is below the rated impedance range indicated on the back panel of the receiver. Reduce the volume level.
- Unplug the AC power cord (mains lead) and let the receiver cool down for 30 minutes while performing the following troubleshooting:
  - \_ Disconnect all of the speakers and subwoofer.
  - \_ Check that the speaker wires are tightly twisted on both ends.
  - \_ Connect the front speaker first, increase the volume level and operate the receiver for at least 30 minutes until it completely warms up. Then, connect each additional speaker one by one and test each additional speaker until you detect which speaker is causing the protection error.

After checking the above items and fixing any problems, plug in the AC power cord (mains lead) and turn on the receiver. If the problem persists, consult your nearest Sony dealer.

### Notes on use

4-488-933-11(1)

Copyright 2014 Sony Corporation



MULTI CHANNEL AV RECEIVER  
STR-DH750/STR-DH550

## USB FAIL

---

An over-current from the  $\psi$  (USB) port was detected. The receiver will automatically turn off after a few seconds. Check the iPhone/iPod or USB device, then unplug it and turn on the power again.

### Notes on use

4-488-933-11(1)

Copyright 2014 Sony Corporation



MULTI CHANNEL AV RECEIVER  
STR-DH750/STR-DH550

## List of messages after Auto Calibration measurements

---

- **Error 30:**

Headphones are connected to the PHONES jack on the receiver. Remove the headphones and perform the Auto Calibration again.

- **Error 31:**

Front speakers are not selected properly. Select the front speakers using SPEAKERS and perform the Auto Calibration again. For details on selecting the front speakers, see [“Selecting the front speakers \(for STR-DH750 only\).”](#)

- **Error 32, Error 33:**

- \_Speakers were not detected or not connected properly.
- \_None of the front speakers are connected or only one front speaker is connected.
- \_Either the surround left or surround right speaker is not connected.
- \_A surround back speaker is connected only to the SPEAKERS SURROUND BACK/BI-AMP/FRONT HIGH/FRONT B R terminal. If connecting only one surround back speaker, connect it to the SPEAKERS SURROUND BACK/BI-AMP/FRONT HIGH/FRONT B L terminal (for STR-DH750 only).
- \_Either the front high left or front high right speaker is not connected.

The optimizer microphone is not connected. Make sure that the optimizer microphone is connected properly and perform the Auto Calibration again.

If the optimizer microphone is connected properly but the error code still appears, the optimizer microphone cable may be damaged.

- **Warning 40:**

The measurement process has been completed and a high noise level has been detected. You may be able to achieve better results if you try the process again in a quiet environment.

- **Warning 41, Warning 42:**

The input from the microphone is too large.

- \_The distance between the speaker and the microphone may be too small. Set them further apart and perform the measurement again.

- **Warning 43:**

The distance and position of a subwoofer cannot be detected. This may be caused by noise. Try performing the measurement in a quiet environment.

### [Notes on use](#)

4-488-933-11(1)

Copyright 2014 Sony Corporation



MULTI CHANNEL AV RECEIVER  
STR-DH750/STR-DH550

## iPhone/iPod message list

---

- **Reading:**  
The receiver is recognizing and reading the information of the iPhone or iPod.
- **Loading:**  
The receiver is loading information of the iPhone or iPod.
- **Not supported:**  
An incompatible iPhone or iPod is connected.
- **No device is connected:**  
No iPhone or iPod is connected.
- **No Music:**  
No music was found.
- **Headphones not supported:**  
No sound is output from the headphones when an iPhone or iPod is connected.

### [Notes on use](#)

4-488-933-11(1)

Copyright 2014 Sony Corporation



MULTI CHANNEL AV RECEIVER  
STR-DH750/STR-DH550

## USB message list

---

- **Reading:**  
The receiver is recognizing and reading the information of the USB device.
- **Device error:**  
The memory of the USB device could not be recognized.
- **Not supported:**  
An incompatible USB device is connected, an unknown device is connected, or the USB device is connected through a USB hub.
- **No device is connected:**  
No USB device is connected or the connected USB device is not recognized.
- **No track:**  
No track was found.

### Notes on use

4-488-933-11(1)

Copyright 2014 Sony Corporation



MULTI CHANNEL AV RECEIVER  
STR-DH750/STR-DH550

The receiver is turned off automatically.

---

- [Auto Standby] is set to [On].
- The sleep timer function was activated.
- [PROTECTOR] was activated.

## Related Topic

- [Setting standby mode \(Auto Standby\)](#)
- [Using the sleep timer](#)
- [PROTECTOR](#)

## Notes on use

4-488-933-11(1)

Copyright 2014 Sony Corporation



MULTI CHANNEL AV RECEIVER  
STR-DH750/STR-DH550

No image appears on the TV.

---

- Select the appropriate input using the input buttons.
- Set your TV to the appropriate input mode.
- Move your audio device away from the TV.
- Assign the video input correctly.
- Make sure that cables are correctly and securely connected to devices.
- Some playback devices need to be set up. Refer to the operating instructions supplied with each device.
- Be sure to use a High Speed HDMI cable when you view images or listen to sound, especially for 1080p, Deep Color (Deep Colour), 4K or 3D transmission.

#### Notes on use

4-488-933-11(1)

Copyright 2014 Sony Corporation



MULTI CHANNEL AV RECEIVER  
STR-DH750/STR-DH550

No 3D image appears on the TV.

---

- Depending on the TV or the video device, 3D images may not be displayed. Check the HDMI video formats supported by the receiver.
- Be sure to use a High Speed HDMI cable.

[Notes on use](#)

4-488-933-11(1)

Copyright 2014 Sony Corporation



MULTI CHANNEL AV RECEIVER  
STR-DH750/STR-DH550

No 4K image appears on the TV.

---

- Depending on the TV or the video device, 4K images may not be displayed. Check the video capability and settings of your TV and video device. Also, make sure you connect the video device to the 4K-compatible HDMI IN jack of this receiver.
- Be sure to use a High Speed HDMI cable.

#### Notes on use

4-488-933-11(1)

Copyright 2014 Sony Corporation



MULTI CHANNEL AV RECEIVER  
STR-DH750/STR-DH550

No image is output from the TV when the receiver is in standby mode.

---

- When the receiver enters standby mode, the image from the last HDMI device selected before you turned off the receiver is displayed. If you are enjoying content from another device, play the content on the device and perform the One-Touch Play operation, or turn on the receiver to select the HDMI device from which you want to enjoy content.
- Make sure [Pass Through] is set to [On] (For USA, Canadian, and Australian models only) or [Auto] in the HDMI Settings menu.

Related Topic

- [Passing HDMI signals through \(Pass Through\)](#)

[Notes on use](#)

4-488-933-11(1)

Copyright 2014 Sony Corporation



MULTI CHANNEL AV RECEIVER  
STR-DH750/STR-DH550

The OSD menu does not appear on the TV screen.

---

- OSD is only available when you connect the TV to the HDMI TV OUT jack.
- Press HOME to turn the OSD on.
- Check that the TV is connected correctly.
- Depending on the TV, the OSD menu may take some time to appear on the TV screen.

#### Notes on use

4-488-933-11(1)

Copyright 2014 Sony Corporation



MULTI CHANNEL AV RECEIVER  
STR-DH750/STR-DH550

The display panel is turned off.

---

- If the PURE DIRECT indicator on the front panel lights up, press PURE DIRECT to turn off this function.
- Press DIMMER on the receiver to adjust the brightness of the display panel.

#### Notes on use

4-488-933-11(1)

Copyright 2014 Sony Corporation



MULTI CHANNEL AV RECEIVER  
STR-DH750/STR-DH550

No sound or only a very low level of sound is heard, no matter which device is selected.

---

- Check that all connecting cables are inserted to their input/output jacks on the receiver, speakers and the devices.
- Check that the receiver and all devices are turned on.
- Check that MASTER VOLUME on the receiver is not set to [VOL MIN].
- Check that SPEAKERS on the receiver is not set to [SPK OFF].
- Check that headphones are not connected to the receiver.
- Press  to cancel the muting function.
- Try pressing the input button on the remote control or turning INPUT SELECTOR on the receiver to select the device of your choice.
- If you want to listen to sound from the TV speaker, set [HDMI Audio Out] to [TV+AMP] in the HDMI Settings menu. If you cannot play multi-channel audio source, set [AMP] . However, the sound will not be output through the TV speaker.
- Sound may be interrupted when the sampling frequency, number of channels or audio format of audio output signals from the playback device is switched.

#### Notes on use

4-488-933-11(1)

Copyright 2014 Sony Corporation





MULTI CHANNEL AV RECEIVER  
STR-DH750/STR-DH550

There is severe humming or noise.

---

- Check that the speakers and device are connected securely.
- Check that the connecting cables are not near a transformer or motor, and are at least 3 meters (10 feet) away from a TV set or fluorescent light.
- Move your audio device away from the TV.
- The plugs and jacks are dirty. Wipe them with a cloth slightly moistened with alcohol.

[Notes on use](#)

4-488-933-11(1)

Copyright 2014 Sony Corporation



MULTI CHANNEL AV RECEIVER  
STR-DH750/STR-DH550

No sound or only a very low level of sound is heard from specific speakers.

---

- Connect a pair of headphones to the PHONES jack to verify that sound is output from the headphones. If only one channel is output from the headphones, the device may not be connected to the receiver correctly. Check that all of the cables are fully inserted into the jacks on both the receiver and the device. If both channels are output from the headphones, the front speaker may not be connected to the receiver correctly. Check the connection of the front speaker that is not outputting any sound.
- Make sure you have connected to both the L and R jacks of an analog device, as analog devices require both L and R jack connections. Use an audio cable (not supplied).
- Adjust the speaker level.
- Check that the speaker settings are appropriate for the setup using [Auto Calibration] or [Speaker Pattern] in the Speaker Settings menu. Then check that sound is output from each speaker correctly using [Test Tone] in the Speaker Settings menu.
- Some discs have no Dolby Digital Surround EX information. In this case, sound may not be output from some speakers.
- Check that the subwoofer is connected correctly and securely.
- Make sure you have turned on your subwoofer.
- Depending on the selected sound field, sound may not be available from the subwoofer.
- There is no sound from the subwoofer when all speakers are set to [Large] and [Neo:6 Cinema] (\*) or [Neo:6 Music] (\*) is selected.

\* for STR-DH750 only

#### Notes on use

4-488-933-11(1)

Copyright 2014 Sony Corporation



MULTI CHANNEL AV RECEIVER  
STR-DH750/STR-DH550

There is no sound from a specific device.

---

- Check that the device is correctly connected to the corresponding audio input jacks.
- Check that the cable(s) used for the connection is (are) fully inserted into the jacks on both the receiver and the device.
- Check the Input Mode setting.
- Check that the device is correctly connected to the corresponding HDMI jack.
- You cannot listen to the Super Audio CD via an HDMI connection.
- The HDMI settings of some playback devices need to be configured. Refer to the operating instructions supplied with each device.
- Be sure to use a High Speed HDMI cable when you view images or listen to sound, especially for 1080p, Deep Color (Deep Colour), 4K or 3D transmission.
- Audio signals (format, sampling frequency, bit length, etc.) transmitted from an HDMI jack may be suppressed by the connected device. Check the setup of a device connected via an HDMI cable if the image is poor or the sound does not come out of the device.
- When a connected device does not support the copyright protection technology (HDCP), the image and/or the sound from the HDMI OUT jack may be distorted or may not be output. If this is the case, check the specifications of the connected device.
- Set the image resolution of the playback device to more than 720p/1080i to enjoy High Bitrate Audio (DTS-HD Master Audio, Dolby TrueHD).
- The image resolution of the playback device may need to be configured to certain settings before you can enjoy Multi Channel Linear PCM. Refer to the operating instructions of the playback device.
- Make sure the TV supports the System Audio Control function.
- If the TV does not have a System Audio Control function, set [HDMI Audio Out] in the HDMI Settings menu to:
  - [TV+AMP] if you want to listen to the sound from the TV speaker and receiver.
  - [AMP] if you want to listen to the sound from the receiver only.
- When you connect the receiver to a video device (projector, etc.), sound may not be output from the receiver. In this case, set [HDMI Audio Out] to [AMP] in the HDMI Settings menu.
- You cannot listen to the sound of a device connected to the receiver while TV input is selected on the receiver.
  - Be sure to change the input of the receiver to HDMI if you want to watch a program on a device connected via HDMI connection to the receiver.
  - Change the TV channel if you want to watch a TV broadcast.
  - Be sure to select the correct device or input when watching a program from a device connected to the TV. Refer to the section on this operation in the operating instructions of the TV.
- When [Analog Direct] is being used, sound is not output. Use another sound field.
- When using the Control for HDMI function, you cannot control connected devices using the remote control of the TV.
  - Some devices and TVs need to be set up. Refer to the operating instructions supplied with each device and TV.
  - Change the input of the receiver to the HDMI input connected to the device.

- Check that the selected digital audio input jack is not assigned to another input.

### Notes on use

4-488-933-11(1)

Copyright 2014 Sony Corporation



MULTI CHANNEL AV RECEIVER  
STR-DH750/STR-DH550

The left and right sound is unbalanced or reversed.

---

- Check that the speakers and device are connected correctly and securely.
- Adjust the sound level parameters using the Speaker Settings menu.

#### Notes on use

4-488-933-11(1)

Copyright 2014 Sony Corporation



MULTI CHANNEL AV RECEIVER  
STR-DH750/STR-DH550

Dolby Digital or DTS multi-channel sound is not reproduced.

---

- Check that the DVD, etc. you are playing is recorded in Dolby Digital or DTS format.
- When connecting the DVD player, etc., to the digital input jacks of this receiver, make sure the digital audio output setting of the connected device is available.
- Set [HDMI Audio Out] to [AMP] in the HDMI Settings menu.
- You can only enjoy High Bitrate Audio (DTS-HD Master Audio, Dolby TrueHD), DSD (for non-USA and Canadian models only) and Multi Channel Linear PCM with an HDMI connection.

#### Notes on use

4-488-933-11(1)

Copyright 2014 Sony Corporation



MULTI CHANNEL AV RECEIVER  
STR-DH750/STR-DH550

The surround effect cannot be obtained.

---

- Make sure you have selected a sound field for movies or music.
- [PLII Movie], [PLII Music], [PLIIX Movie] (\*), [PLIIX Music] (\*), [Neo:6 Cinema] (\*) and [Neo:6 Music] (\*) do not work when the speaker pattern is set to 2/0 or 2/0.1.

\* for STR-DH750 only

#### Notes on use

4-488-933-11(1)

Copyright 2014 Sony Corporation



MULTI CHANNEL AV RECEIVER  
STR-DH750/STR-DH550

A test tone is not output from the speakers.

---

- The speaker cables may not be connected securely. Check that they are connected securely and cannot be disconnected by pulling on them slightly.
- The speaker cables may have short-circuited.

#### Notes on use

4-488-933-11(1)

Copyright 2014 Sony Corporation





MULTI CHANNEL AV RECEIVER  
STR-DH750/STR-DH550

A test tone is output from a different speaker than the speaker displayed on the TV screen.

---

- The speaker pattern setup is incorrect. Make sure that the speaker connections and the speaker pattern match correctly.

#### Notes on use

4-488-933-11(1)

Copyright 2014 Sony Corporation



MULTI CHANNEL AV RECEIVER  
STR-DH750/STR-DH550

No sound is output from the TV when the receiver is in standby mode.

---

- When the receiver enters standby mode, sound is output from the last HDMI device selected before you turned off the receiver. If you are enjoying content from another device, play the content on the device and perform the One-Touch Play operation, or turn on the receiver to select the HDMI device from which you want to enjoy content.
- Make sure [Pass Through] is set to [On] (For USA, Canadian, and Australian models only) or [Auto] in the HDMI Settings menu.

Related Topic

- [Passing HDMI signals through \(Pass Through\)](#)

[Notes on use](#)

4-488-933-11(1)

Copyright 2014 Sony Corporation

MULTI CHANNEL AV RECEIVER  
STR-DH750/STR-DH550

The FM reception is poor.

- Use a 75-ohm coaxial cable (not supplied) to connect the receiver to an outdoor FM antennas (aerial) as shown below.

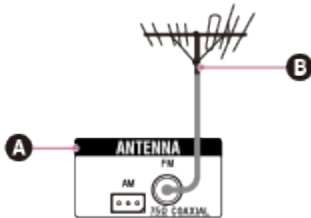

- Ⓐ Receiver
- Ⓑ Outdoor FM antenna (aerial)

## Related Topic

- [The FM stereo reception is poor.](#)

## Notes on use

4-488-933-11(1)

Copyright 2014 Sony Corporation



MULTI CHANNEL AV RECEIVER  
STR-DH750/STR-DH550

The FM stereo reception is poor.

---

Perform the following procedure:

1. Select [Listen] - [FM] from the home menu.
2. Tune in the station you want.
3. Press OPTIONS.
4. Select [FM Mode] from the options menu.
5. Select [Mono].

#### Notes on use

4-488-933-11(1)

Copyright 2014 Sony Corporation



MULTI CHANNEL AV RECEIVER  
STR-DH750/STR-DH550

You cannot tune to radio stations.

---

- Check that the antennas (aerials) are connected securely. Adjust the antennas (aerials) and connect an external antenna (aerial) if necessary.
- The signal of the stations is too weak with automatic tuning. Use direct tuning.
- Make sure you set the tuning scale correctly (when tuning to AM stations with direct tuning).
- No stations have been preset or the preset stations have been cleared (when tuning by scanning preset stations is used). Preset the stations.
- Press DISPLAY repeatedly on the remote control so that the frequency appears on the display panel.

#### Notes on use

4-488-933-11(1)

Copyright 2014 Sony Corporation



MULTI CHANNEL AV RECEIVER  
STR-DH750/STR-DH550

RDS does not work (for European and Australian models only).

---

- Make sure that you are tuned to an FM RDS station.
- Select a stronger FM station.
- The station you tuned to is not transmitting the RDS signal or the signal is weak.

[Notes on use](#)

4-488-933-11(1)

Copyright 2014 Sony Corporation



MULTI CHANNEL AV RECEIVER  
STR-DH750/STR-DH550

The RDS information that you want does not appear (for European and Australian models only).

---

- The service may be temporarily out of order. Contact the radio station and find out whether they actually provide the service in question.

#### Notes on use

4-488-933-11(1)

Copyright 2014 Sony Corporation



MULTI CHANNEL AV RECEIVER  
STR-DH750/STR-DH550

The sound is distorted.

---

- Press  - on the remote control repeatedly. You can also use MASTER VOLUME on the receiver.

Notes on use

4-488-933-11(1)

Copyright 2014 Sony Corporation





MULTI CHANNEL AV RECEIVER  
STR-DH750/STR-DH550

There is no sound from an iPhone/iPod.

---

- Disconnect the iPhone/iPod and connect it again.

[Notes on use](#)

4-488-933-11(1)

Copyright 2014 Sony Corporation



MULTI CHANNEL AV RECEIVER  
STR-DH750/STR-DH550

An iPhone/iPod cannot be charged.

---

- Check that the receiver is turned on.
- Make sure the iPhone/iPod is connected securely.

[Notes on use](#)

4-488-933-11(1)

Copyright 2014 Sony Corporation



MULTI CHANNEL AV RECEIVER  
STR-DH750/STR-DH550

An iPhone/iPod cannot be operated.

---

- Depending on the content of the iPhone/iPod, it may take time to start playback.
- Turn off the receiver, then disconnect the iPhone/iPod. Turn on the receiver again and reconnect the iPhone/iPod.
- You are using an incompatible iPhone/iPod. See “[Compatible iPhone/iPod models](#)” for the compatible device types.

[Notes on use](#)

4-488-933-11(1)

Copyright 2014 Sony Corporation



MULTI CHANNEL AV RECEIVER  
STR-DH750/STR-DH550

The ringtone volume of an iPhone does not change.

---

- Adjust the ring volume using the controls on the iPhone.

[Notes on use](#)

4-488-933-11(1)

Copyright 2014 Sony Corporation



MULTI CHANNEL AV RECEIVER  
STR-DH750/STR-DH550

## Are you using a compatible USB device?

---

- If you connect an incompatible USB device, the following problems may occur. See “[Compatible USB devices and USB specifications](#)” for the compatible device types.
  - \_ The USB device is not recognized.
  - \_ File or folder names are not displayed on this receiver.
  - \_ Playback is not possible.
  - \_ The sound skips.
  - \_ There is noise.
  - \_ Distorted sound is output.

### Notes on use

4-488-933-11(1)

Copyright 2014 Sony Corporation



MULTI CHANNEL AV RECEIVER  
STR-DH750/STR-DH550

There is noise, skipping, or distorted sound.

---

- Turn off the receiver, reconnect the USB device, and then turn on the receiver.
- The music data itself contains noise, or the sound is distorted.

#### Notes on use

4-488-933-11(1)

Copyright 2014 Sony Corporation



MULTI CHANNEL AV RECEIVER  
STR-DH750/STR-DH550

A USB device is not recognized.

---

- Turn off the receiver, then disconnect the USB device. Turn on the receiver again and reconnect the USB device.
- Connect a compatible USB device.
- The USB device does not work properly. Refer to the section on how to deal with this problem in the operating instructions of the USB device.

#### [Notes on use](#)

4-488-933-11(1)

Copyright 2014 Sony Corporation



MULTI CHANNEL AV RECEIVER  
STR-DH750/STR-DH550

Playback does not start.

---

- Turn off the receiver, reconnect the USB device, and then turn on the receiver.
- Connect a compatible USB device.
- Select [USB] and select a folder/track, then press ►|| to start playback.

[Notes on use](#)

4-488-933-11(1)

Copyright 2014 Sony Corporation





MULTI CHANNEL AV RECEIVER  
STR-DH750/STR-DH550

A USB device cannot be connected to the USB port.

---

- The USB device is being connected upside down. Connect the USB device in the correct orientation.

[Notes on use](#)

4-488-933-11(1)

Copyright 2014 Sony Corporation



MULTI CHANNEL AV RECEIVER  
STR-DH750/STR-DH550

### Erroneous display.

---

- The data stored in the USB device may have been corrupted.
- The character codes that can be displayed by this receiver are as follows:
  - \_Upper case letters (A to Z)
  - \_Lower case letters (a to z)
  - \_Numbers (0 to 9)
  - \_Symbols ( ' = < > \* + , - . / @ [ \ ] \_ ` )

Other characters may not be displayed correctly.

### Notes on use

4-488-933-11(1)

Copyright 2014 Sony Corporation



MULTI CHANNEL AV RECEIVER  
STR-DH750/STR-DH550

[Reading] is displayed for an extended time, or it takes a long time before playback starts.

---

- The reading process can take a long time in the following cases:

- There are many folders or files on the USB device.
- The file structure is extremely complex.
- The memory capacity is excessive.
- The internal memory is fragmented.

We therefore recommend following these guidelines:

- Total folders on USB device: 256 or less (including [ROOT] folder)
- Total files per folder: 256 or less.

#### Notes on use

4-488-933-11(1)

Copyright 2014 Sony Corporation



MULTI CHANNEL AV RECEIVER  
STR-DH750/STR-DH550

An audio file cannot be played.

---

- MP3 files in MP3 PRO format cannot be played.
- The audio file is a multiple track audio file.
- Some AAC files may not be played correctly.
- WMA files in Windows Media Audio Lossless and Professional formats cannot be played.
- USB devices formatted with file systems other than FAT16 or FAT32 are unsupported (\*).
- If you use a partitioned USB device, only audio files on the first partition can be played.
- Playback is possible up to eight levels (including the [ROOT] folder).
- There are more than 256 folders (including the [ROOT] folder).
- There are more than 256 files.
- Files that are encrypted, protected by passwords, etc. cannot be played.

\* The receiver supports FAT16 and FAT32, but some USB devices may not support these FAT systems. For details, refer to the operating instructions of each USB device or contact the manufacturer.

#### Notes on use

4-488-933-11(1)

Copyright 2014 Sony Corporation



MULTI CHANNEL AV RECEIVER  
STR-DH750/STR-DH550

Pairing cannot be done (for STR-DH750 only).

---

- Move the BLUETOOTH device closer to the receiver.
- Pairing may not be possible if there are other BLUETOOTH devices near the receiver. In this case, turn off the other BLUETOOTH devices.
- Correctly enter the same passkey that was entered on the BLUETOOTH device.

#### Notes on use

4-488-933-11(1)

Copyright 2014 Sony Corporation



MULTI CHANNEL AV RECEIVER  
STR-DH750/STR-DH550

Cannot make a BLUETOOTH connection (for STR-DH750 only).

---

- The BLUETOOTH device you attempted to connect does not support the A2DP profile, and cannot be connected with the receiver.
- Press BLUETOOTH on the receiver to connect to the last connected BLUETOOTH device.
- Turn on the BLUETOOTH function of the BLUETOOTH device.
- Establish a connection from the BLUETOOTH device.
- The pairing registration information has been erased. Perform the pairing operation again.
- While connected to a BLUETOOTH device, this receiver cannot be detected and a connection cannot be established from another BLUETOOTH device.
- Erase the pairing registration information of the BLUETOOTH device and perform the pairing operation again.

#### Notes on use

4-488-933-11(1)

Copyright 2014 Sony Corporation



MULTI CHANNEL AV RECEIVER  
STR-DH750/STR-DH550

The sound skips or fluctuates, or the connection is lost (for STR-DH750 only).

---

- The receiver and the BLUETOOTH device are too far apart.
- If there are obstructions between the receiver and your BLUETOOTH device, remove these or move the receiver and/or device avoid them.
- If there is a device that generates electromagnetic radiation, such as a wireless LAN, other BLUETOOTH device, or a microwave oven nearby, move it away.

#### Notes on use

4-488-933-11(1)

Copyright 2014 Sony Corporation



MULTI CHANNEL AV RECEIVER  
STR-DH750/STR-DH550

The sound of your BLUETOOTH device cannot be heard on the receiver (for STR-DH750 only).

---

- Turn up the volume on your BLUETOOTH device first, and then adjust the volume using  $\triangleleft$  + (or MASTER VOLUME on the receiver).

#### Notes on use

4-488-933-11(1)

Copyright 2014 Sony Corporation





MULTI CHANNEL AV RECEIVER  
STR-DH750/STR-DH550

Severe humming or noise (for STR-DH750 only).

---

- If there are obstructions between the receiver and your BLUETOOTH device, remove them or move the receiver and/or device avoid them.
- If there is a device that generates electromagnetic radiation, such as a wireless LAN, other BLUETOOTH device, or a microwave oven nearby, move it away.
- Turn down the volume of the connected BLUETOOTH device.

#### Notes on use

4-488-933-11(1)

Copyright 2014 Sony Corporation



MULTI CHANNEL AV RECEIVER  
STR-DH750/STR-DH550

SongPal application is closed (for STR-DH750 only).

---

- Disconnect the BLUETOOTH connection on your smartphone, then reconnect it to the receiver again.

[Notes on use](#)

4-488-933-11(1)

Copyright 2014 Sony Corporation



MULTI CHANNEL AV RECEIVER  
STR-DH750/STR-DH550

The Control for HDMI function does not work.

---

- Check the HDMI connection.
- Make sure [Control for HDMI] is set to [On] in the HDMI Settings menu.
- Make sure the connected device supports the Control for HDMI function.
- Check the Control for HDMI settings on the connected device. Refer to the operating instructions of the connected device.
- If you unplug the HDMI cable or change the connection, repeat the procedures of [“Preparing for “BRAVIA” Sync.”](#)
- When [Control for HDMI] is set to [Off], “BRAVIA” Sync does not work properly, even if the device is connected to the HDMI IN jack.
- The types and number of devices that can be controlled by the “BRAVIA” Sync feature are restricted by the HDMI CEC standard as follows:
  - Recording devices (Blu-ray Disc recorders, DVD recorders, etc.): up to 3 devices
  - Playback devices (Blu-ray Disc players, DVD players, etc.): up to 3 devices
  - Tuner-related devices: up to 4 devices (the receiver uses one of them for its OSD operations.)
  - AV receivers (audio systems): up to 1 device

#### Notes on use

4-488-933-11(1)

Copyright 2014 Sony Corporation



MULTI CHANNEL AV RECEIVER  
STR-DH750/STR-DH550

The Audio Return Channel (ARC) function does not work.

---

- Make sure [Control for HDMI] is set to [On] in the HDMI Settings menu.
- Make sure [Input Mode] for the TV input is set to [Auto].
- Make sure your TV supports the ARC function.
- If your TV has multiple HDMI input jacks, make sure the receiver is connected to the one supports the ARC function.

Related Topic

- [Controlling HDMI devices \(Control for HDMI\)](#)

Notes on use

4-488-933-11(1)

Copyright 2014 Sony Corporation



MULTI CHANNEL AV RECEIVER  
STR-DH750/STR-DH550

An MHL-compatible source device cannot be charged.

---

- Check that the receiver is turned on.
- Make sure the device is connected securely.

#### Notes on use

4-488-933-11(1)

Copyright 2014 Sony Corporation



MULTI CHANNEL AV RECEIVER  
STR-DH750/STR-DH550

No image from an MHL-compatible source device.

---

- Check the settings of your device. For details, refer to the operating instructions of your device.
- Check that the device is connected via an MHL cable to the HDMI VIDEO IN (MHL) jack.

#### Notes on use

4-488-933-11(1)

Copyright 2014 Sony Corporation



MULTI CHANNEL AV RECEIVER  
STR-DH750/STR-DH550

The remote control does not function.

---

- Point the remote control at the remote control sensor on the receiver.
- Remove any obstructions between the remote control and the receiver.
- Replace both of the batteries in the remote control with new ones if they are weak.

[Notes on use](#)

4-488-933-11(1)

Copyright 2014 Sony Corporation



MULTI CHANNEL AV RECEIVER  
STR-DH750/STR-DH550

## Customer support websites

---

Refer to the following websites for the latest information on the receiver.

**For customers in the USA:**

<http://esupport.sony.com/>

**For customers in Canada:**

<http://esupport.sony.com/CA/>

**For customers in Latin America:**

<http://esupport.sony.com/LA>

**For customers in Europe:**

<http://support.sony-europe.com/>

**For customers in Australia:**

<http://www.sony-asia.com/support>

### Notes on use

4-488-933-11(1)

Copyright 2014 Sony Corporation



MULTI CHANNEL AV RECEIVER  
STR-DH750/STR-DH550

## 5.1-channel speaker system

To fully enjoy theater-like multi-channel surround sound, you need five speakers (two front speakers, a center speaker, and two surround speakers) and a subwoofer.

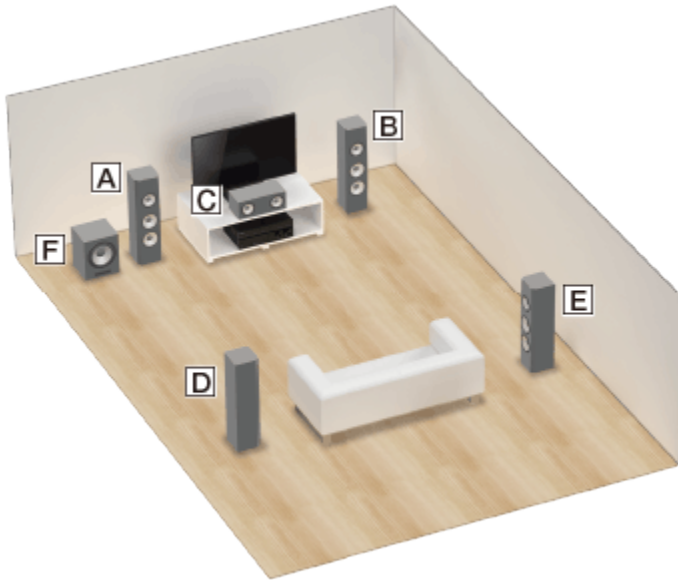

- A Front speaker (Left)**
- B Front speaker (Right)**
- C Center speaker**
- D Surround speaker (Left)**
- E Surround speaker (Right)**
- F Subwoofer**

**Hint**

- As the subwoofer does not emit highly directional signals, you can place it wherever you want.

## Related Topic

- [Connecting speakers](#)

[Notes on use](#)

4-488-933-11(1)

Copyright 2014 Sony Corporation



MULTI CHANNEL AV RECEIVER  
STR-DH750/STR-DH550

### 7.1-channel speaker system using surround back speakers (for STR-DH750 only)

You can enjoy high-fidelity reproduction of recorded sound from DVD or Blu-ray Disc software in 6.1-channel or 7.1-channel format.

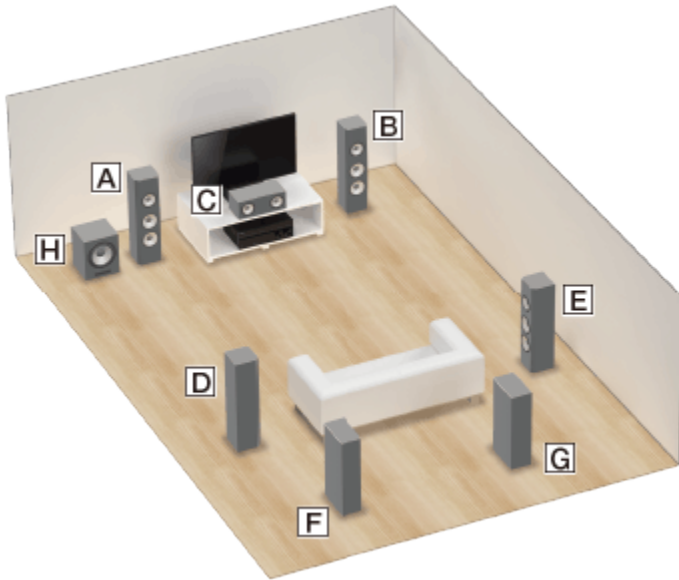

- A Front speaker (Left)**
- B Front speaker (Right)**
- C Center speaker**
- D Surround speaker (Left)**
- E Surround speaker (Right)**
- F Surround back speaker (Left)**
- G Surround back speaker (Right)**
- H Subwoofer**

### 6.1-channel speaker placement

Place the surround back speaker behind the listening position.

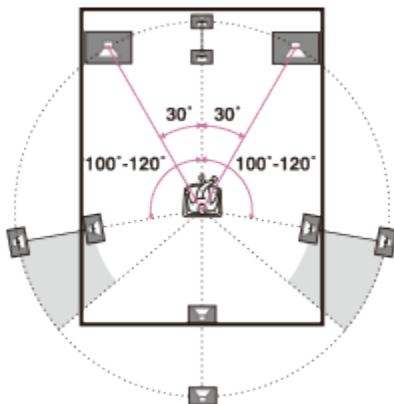

## 7.1-channel speaker placement

Place the surround back speakers as shown in the illustration below. The angles shown by **A** should be the same.

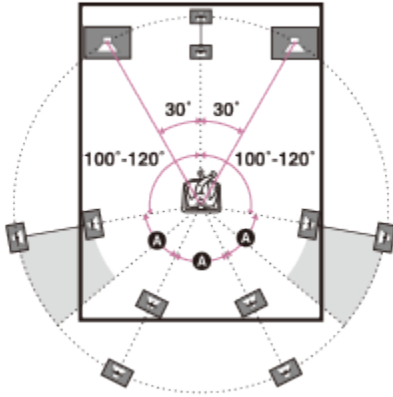

### Hint

- As the subwoofer does not emit highly directional signals, you can place it wherever you want.

Related Topic

● [Connecting speakers](#)

### Notes on use

4-488-933-11(1)

Copyright 2014 Sony Corporation



MULTI CHANNEL AV RECEIVER  
STR-DH750/STR-DH550

7.1-channel speaker system using front high speakers (for STR-DH750 only)

You can enjoy vertical sound effects by connecting additional two front high speakers.

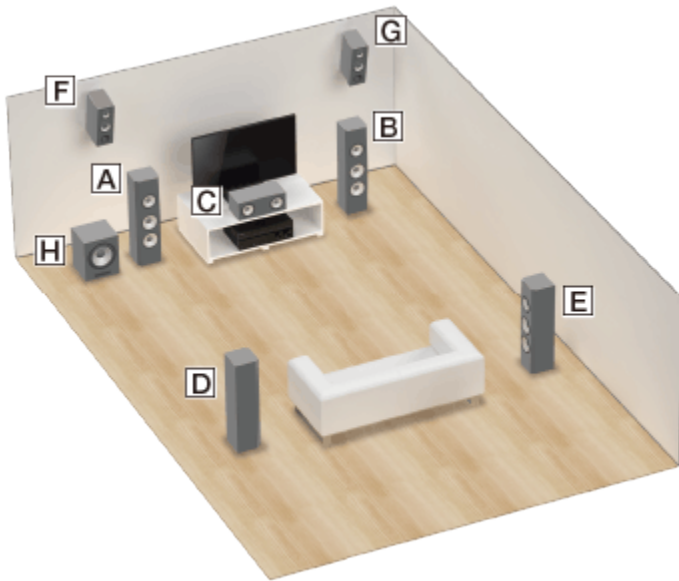

- A Front speaker (Left)**
- B Front speaker (Right)**
- C Center speaker**
- D Surround speaker (Left)**
- E Surround speaker (Right)**
- F Front high speaker (Left)**
- G Front high speaker (Right)**
- H Subwoofer**

1. Place the front high speakers at an angle between 25° and 35°.

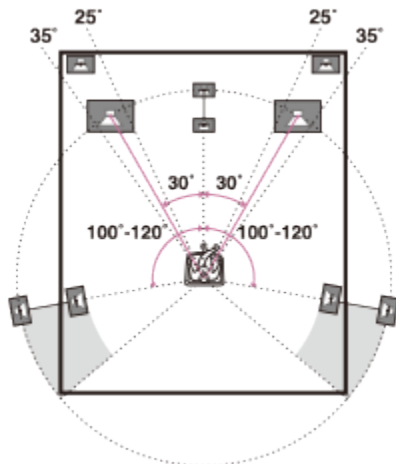

2. Place the front high speakers at height angle of  $20^\circ \pm 5^\circ$ .

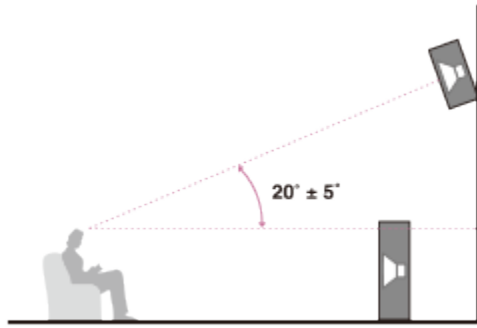

**Hint**

- As the subwoofer does not emit highly directional signals, you can place it wherever you want.

Related Topic

- [Connecting speakers](#)

Notes on use

4-488-933-11(1)

Copyright 2014 Sony Corporation



MULTI CHANNEL AV RECEIVER  
STR-DH750/STR-DH550

How to connect speaker cables

---

Connect speaker cables as illustrated below.

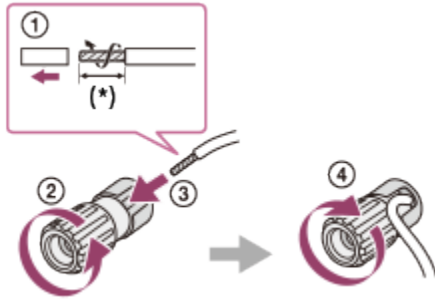

\* Strip the jacket to 10 mm (13/32 in) at each end of the speaker cables.

Notes on use

4-488-933-11(1)

Copyright 2014 Sony Corporation



MULTI CHANNEL AV RECEIVER  
STR-DH750/STR-DH550

### Checking the information of a connected BLUETOOTH device (for STR-DH750 only)

---

You can check the BLUETOOTH device information by pressing DISPLAY repeatedly.

Each time you press DISPLAY, the display will change cyclically as follows:

BLUETOOTH device name - BLUETOOTH device address - Sound field currently applied - Volume level - Input you selected

#### Notes on use

4-488-933-11(1)

Copyright 2014 Sony Corporation



MULTI CHANNEL AV RECEIVER  
STR-DH750/STR-DH550

## Setting the Bluetooth Standby mode (BT Standby) (for STR-DH750 only)

---

You can set the Bluetooth Standby mode so that the receiver can be controlled by a BLUETOOTH device even when the receiver is in standby mode.

1. Press BLUETOOTH on the receiver.  
You can also select [Listen] - [BLUETOOTH] from the home menu.
2. Press OPTIONS.  
The options menu appears.
3. Select [BT Standby].
4. Select [On].  
The receiver turns on automatically when you establish a BLUETOOTH connection from a BLUETOOTH device.  
Select [Off] to turn off this function.

### Note

- When the receiver is in standby mode, the  $\text{I}/\text{O}$  (on/standby) indicator on the front panel lights up in amber if [BT Standby] is set to [On].
- You can only select this parameter when a BLUETOOTH device is paired.

### Notes on use

4-488-933-11(1)

Copyright 2014 Sony Corporation





MULTI CHANNEL AV RECEIVER  
STR-DH750/STR-DH550

## Setting BLUETOOTH audio codecs (BT AAC/BT aptX) (for STR-DH750 only)

---

You can enable and disable AAC (Advanced Audio Coding) or aptX audio.

1. Press BLUETOOTH on the receiver.  
You can also select [Listen] - [BLUETOOTH] from the home menu.
2. Press OPTIONS.  
The option menu appears.
3. Select [BT AAC] or [BT aptX].
4. Select [On] or [Off].
  - **On:** AAC and/or aptX audio is available.
  - **Off:** AAC and/or aptX audio is not available.

### Note

- You can enjoy high-quality sound if AAC or aptX is enabled.
- When you change this setting, the BLUETOOTH device is disconnected from the receiver automatically.

### Notes on use

4-488-933-11(1)

Copyright 2014 Sony Corporation



MULTI CHANNEL AV RECEIVER  
STR-DH750/STR-DH550

## Naming preset stations (Name Input)

---

You can enter a name up to 8 characters for a preset station.

1. Select [Listen] - [FM] or [AM] from the home menu.
2. Select the preset number to which you want to assign a name.
3. Press OPTIONS.  
The options menu appears.
4. Select [Name Input].
5. Press  $\uparrow$  /  $\downarrow$  repeatedly to select a character, then press  $\rightarrow$ .  
You can move the input position backward and forward by pressing  $\leftarrow$  /  $\rightarrow$ .
6. Repeat step 5 to input characters one by one, then press  $\oplus$ .  
The name you entered is registered.

### Canceling naming input

Press RETURN.

### Notes on use

4-488-933-11(1)

Copyright 2014 Sony Corporation



MULTI CHANNEL AV RECEIVER  
STR-DH750/STR-DH550

## Auto Format Direct (A.F.D.)/2-channel sound mode

---

- **Auto Format Direct (A.F.D.) mode:** This mode allows you to listen to higher-fidelity sound and select the decoding mode for listening to a 2-channel stereo or monaural sound as multi-channel sound.
- **2-channel sound mode:** You can switch the output sound to 2-channel sound regardless of the recording formats of the software you are using, the playback device connected, or the sound field settings of the receiver.

### **A.F.D. Auto (A.F.D. AUTO):**

Presets the sound as it was recorded/encoded without adding any surround effects.

However, for USA and Canada models, this receiver will generate a low-frequency signal for output to the subwoofer when there is no LFE signals.

### **Multi Stereo (MULTI ST.):**

Outputs 2-channel left/right or monaural signals from all speakers. However, sound may not be output from certain speakers depending on the speaker settings.

### **2ch Stereo (2CH ST.):**

The receiver outputs the sound from the front left/right speakers only. There is no sound from the subwoofer. Standard 2-channel stereo sources completely bypass the sound field processing and multi-channel surround formats are downmixed to 2-channels.

### **Analog Direct (A. DIRECT):**

You can switch the audio of the selected input to 2-channel analog input. This function enables you to enjoy high-quality analog sources.

Only the volume and front speaker level can be adjusted when using this function.

#### **Note**

- You cannot select [Analog Direct] while using the BD/DVD, GAME, or USB function.
- [Multi Stereo] does not work when multi-channel audio signals are being received.

### [Notes on use](#)

4-488-933-11(1)

Copyright 2014 Sony Corporation



MULTI CHANNEL AV RECEIVER  
STR-DH750/STR-DH550

## Movie mode

---

You can take advantage of surround sound simply by selecting one of the receiver's pre-programmed sound fields. They bring the exciting and powerful sound of movie theaters into your home.

### **HD-D.C.S.:**

HD Digital Cinema Sound (HD-D.C.S.) is Sony's new innovative home theater technology using the latest acoustic and digital signal processing technologies. It is based on the precise response measurement data of a mastering studio.

With this mode, you can enjoy Blu-ray and DVD movies at home with not only a high-quality of sound but also the best sound ambience, just as the movie's sound engineer intended in the mastering process.

- **Dynamic:** This setting is suitable for an environment which is reverberant but lacks a spacious feel (where sound absorption is not sufficient). It emphasizes the reflection of sound and reproduces the sound of a large, classic movie theater. This emphasizes the spacious feel of a dubbing theater and creates a unique acoustic field.
- **Theater:** This setting is suitable for a general living room. It reproduces the reverberation of sound just like in a movie theater (dubbing theater). It is most appropriate for watching content recorded on a Blu-ray Disc when you want the atmosphere of a movie theater.
- **Studio:** This setting is suitable for a living room with the appropriate sound devices. It reproduces the reverberation of sound provided when a theatrical sound source is remixed for a Blu-ray Disc to a volume level suitable for home use. The level of reflection and reverberation of sound is kept to a minimum, while dialogues and surround effects are reproduced vividly.

### **PLII Movie (PLII MV):**

Performs Dolby Pro Logic II Movie mode decoding. This setting is ideal for movies encoded in Dolby Surround. In addition, this mode can reproduce sound in 5.1-channel format when watching videos of overdubbed or old movies.

### **PLIIX Movie (PLIIX MV) (for STR-DH750 only):**

Performs Dolby Pro Logic IIX Movie mode decoding. This setting expands Dolby Pro Logic II Movie or Dolby Digital 5.1 to 7.1 discrete movie channels.

### **Neo:6 Cinema (NEO6 CIN) (for STR-DH750 only):**

Performs DTS Neo:6 Cinema mode decoding. Sources recorded in 2-channel format are enhanced up to 7 channels.

## Notes on use



MULTI CHANNEL AV RECEIVER  
STR-DH750/STR-DH550

## Music mode

---

You can take advantage of surround sound simply by selecting one of the receiver's pre-programmed sound fields. These bring the exciting and powerful sound of concert halls into your home.

### **Hall (HALL):**

Reproduces the acoustics of a classical concert hall.

### **Jazz Club (JAZZ):**

Reproduces the acoustics of a jazz club.

### **Live Concert (CONCERT):**

Reproduces the acoustics of a 300-seat live house.

### **Stadium (STADIUM):**

Reproduces the feel of a large open-air stadium.

### **Sports (SPORTS):**

Reproduces the feel of sports broadcasting.

### **Portable Audio (PORTABLE):**

Reproduces clear enhanced sound from your portable audio device. This mode is ideal for MP3s and other compressed music.

### **PLII Music (PLII MS):**

Performs Dolby Pro Logic II Music mode decoding. This setting is ideal for normal stereo sources such as CDs.

### **PLIIX Music (PLIIX MS) (for STR-DH750 only):**

Performs Dolby Pro Logic IIX Music mode decoding. This setting is ideal for normal stereo sources such as CDs.

### **Neo:6 Music (NEO6 MUS) (for STR-DH750 only):**

Performs DTS Neo:6 Music mode decoding. Sources recorded in 2-channel format are enhanced up to 7 channels. This setting is ideal for normal stereo sources such as CDs.

## Notes on use

4-488-933-11(1)

Copyright 2014 Sony Corporation



MULTI CHANNEL AV RECEIVER  
STR-DH750/STR-DH550

## When headphones are connected

---

You can only select this sound field if headphones are connected to the receiver.

### **HP 2CH:**

This mode is selected automatically if you use headphones (except when [Analog Direct] is selected). Standard 2-channel stereo sources completely bypass the sound field processing and multi-channel surround formats are downmixed to 2 channels except LFE signals.

### **HP Direct (HP DIRECT):**

This mode is selected automatically if you use headphones when [Analog Direct] is selected. This mode outputs analog signals without processing by the equalizer, sound field, etc.

### [Notes on use](#)

4-488-933-11(1)

Copyright 2014 Sony Corporation



MULTI CHANNEL AV RECEIVER  
STR-DH750/STR-DH550

## Enjoying an input source from a connected device immediately (One-Touch Play)

---

When you play content on a device connected to the receiver via an HDMI connection, the receiver is also automatically turned on and switched to the appropriate HDMI input.

### Note

- Depending on the TV, the start of the content may not appear.

### Related Topic

- [Passing HDMI signals through \(Pass Through\)](#)

### Notes on use

4-488-933-11(1)

Copyright 2014 Sony Corporation



MULTI CHANNEL AV RECEIVER  
STR-DH750/STR-DH550

## Enjoying TV sound from the speakers connected to the receiver (System Audio Control)

---

You can use the System Audio Control function as follows:

- The sound of the TV is output from the speakers connected to the receiver if you turn the receiver on while sound is being output from the TV speaker. If you turn off the receiver, the sound is output from the TV speaker.
- When you adjust the TV volume, the System Audio Control function adjusts the volume of the receiver simultaneously.

### Note

- When [Control for HDMI] is set to [On], the [HDMI Audio Out] settings in the HDMI Settings menu will be set automatically based on the System Audio Control settings.

### Hint

- You can also operate this function using the TV menu. For details, refer to the operating instructions of the TV.

### Notes on use

4-488-933-11(1)

Copyright 2014 Sony Corporation







MULTI CHANNEL AV RECEIVER  
STR-DH750/STR-DH550

### Turning off the receiver and connected devices simultaneously with the TV (System Power-Off)

---

If the TV, receiver and any connected devices are connected to each other via HDMI connections, you can turn them off simultaneously by pressing either of the following buttons:

-  on the remote control of the TV
-  on the remote control of the receiver

**Note**

- Turn on the power supply interlock function of the TV before using the System Power-Off function. For details, refer to the operating instructions of the TV.
- Some connected devices may not be turned off depending on their specifications. For details, refer to the operating instructions of the connected device.

#### Notes on use

4-488-933-11(1)

Copyright 2014 Sony Corporation



MULTI CHANNEL AV RECEIVER  
STR-DH750/STR-DH550

## Selecting the optimum picture quality and sound field automatically (Scene Select)

---

The optimum picture quality and sound field are selected automatically according to the scene selected on your TV.

For details on this operation, refer to the operating instructions of the TV.

### Switching the sound field for the scene selected on your TV (Scene: Sound field)

- **Cinema:** HD-D.C.S.
- **Sports:** Sports
- **Music:** Live Concert
- **Animation:** A.F.D. Auto
- **Photo:** A.F.D. Auto
- **Game:** A.F.D. Auto
- **Graphics:** A.F.D. Auto

#### Note

- The sound field may not change depending on some TVs.

#### Notes on use

4-488-933-11(1)

Copyright 2014 Sony Corporation



MULTI CHANNEL AV RECEIVER  
STR-DH750/STR-DH550

## Home Theatre Control

---

If a Home Theatre Control-compatible TV is connected to the receiver, an icon for Internet based applications appears on the connected TV.

You can switch an input of the receiver or switch sound fields by using the remote control of your TV. You can also adjust the level of the center speaker or the subwoofer, or adjust the settings of [Dual Mono] or [A/V Sync].

### Note

- Your TV must be able to access a broadband service to use the Home Theatre Control function.

### Notes on use

4-488-933-11(1)

Copyright 2014 Sony Corporation



MULTI CHANNEL AV RECEIVER  
STR-DH750/STR-DH550

## Operating the receiver menu using the TV remote control (Remote Easy Control)

---

You can use the remote control of the TV to operate the menu of the receiver. For details, refer to the operating instructions of the TV.

### Note

- The receiver is recognized as [Tuner] by the TV.
- Your TV must support the link menu.
- Some of the operations may not be available depending on the type of TV.

### Notes on use

4-488-933-11(1)

Copyright 2014 Sony Corporation

MULTI CHANNEL AV RECEIVER  
STR-DH750/STR-DH550

## Before you perform Auto Calibration

Before you perform Auto Calibration, check the following items:

- Set up and connect the speakers.
- Do not connect any microphones other than the supplied optimizer microphone to the AUTO CAL MIC jack.
- If using a bi-amplifier connection or speakers with a front B connection, set the assignment for the SPEAKERS SURROUND BACK/BI-AMP/FRONT HIGH/FRONT B terminals properly. For details, see [“Setting the assignment for the speaker terminals \(SB Assign\) \(for STR-DH750 only\).”](#)
- Set the speaker output to a setting other than [SPK OFF]. For details, see [“Selecting the front speakers \(for STR-DH750 only\).”](#)
- Disconnect the headphones.
- Remove any obstructions between the optimizer microphone and the speakers.
- For accurate measurement, make sure the environment is quiet and free from noise.

**Note**

- The speakers emit very loud sound during the calibration and the volume cannot be adjusted. Be considerate of your neighbor and any children who are present.
- If the muting function has been activated before you perform Auto Calibration, the muting function will shut off automatically.
- It may not be possible to take the correct measurements or to perform Auto Calibration at all if special speakers such as dipole speakers are used.

## Related Topic

- [Confirming active subwoofer setup](#)
- [Selecting the front speakers \(for STR-DH750 only\)](#)
- [Connecting the optimizer microphone](#)

## Notes on use

4-488-933-11(1)

Copyright 2014 Sony Corporation



MULTI CHANNEL AV RECEIVER  
STR-DH750/STR-DH550

## Connecting the optimizer microphone

---

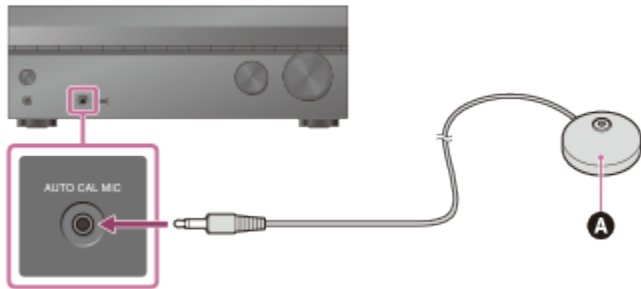

**A** Optimizer microphone (supplied)

1. Connect the supplied optimizer microphone to the AUTO CAL MIC jack.
2. Set up the optimizer microphone.  
Place the optimizer microphone where you will sit and set it at the same height as your ears.

### Notes on use

4-488-933-11(1)

Copyright 2014 Sony Corporation



MULTI CHANNEL AV RECEIVER  
STR-DH750/STR-DH550

### Selecting the front speakers (for STR-DH750 only)

You can select the front speakers you want to operate.  
Be sure to use the buttons on the receiver to perform this operation.

1. Press SPEAKERS repeatedly to select the front speaker system you want to operate.



The indicators on the display panel shows which set of terminals are selected.

- **SP A:**  
Speakers connected to the SPEAKERS FRONT A terminals.
- **SP B (\*):**  
Speakers connected to the SPEAKERS SURROUND BACK/BI-AMP/FRONT HIGH/FRONT B terminals.
- **SP A B (\*):**  
Speakers connected to both the SPEAKERS FRONT A and SPEAKERS SURROUND BACK/BI-AMP/FRONT HIGH/FRONT B terminals (parallel connection).
- **(None):**  
[SPK OFF] appears on the display panel. No audio signals are output from any speaker terminals.

\* To select [SP B] or [SP A B], set the assignment for the SPEAKERS SURROUND BACK/BI-AMP/FRONT HIGH/FRONT B terminals to [Speaker B] by using [SB Assign] in the Speaker Settings menu.

**Note**

- This setting is not available when headphones are connected.

#### Notes on use

4-488-933-11(1)

Copyright 2014 Sony Corporation

MULTI CHANNEL AV RECEIVER  
STR-DH750/STR-DH550About Auto Calibration

---

Auto Calibration allows you to perform automatic calibration as follows.

- Check the connection between each speaker and the receiver.
- Adjust the speaker level.
- Measure the distance of each speaker from your seating position. (\*)
- Measure the speaker size. (\*)
- Measure the frequency characteristics (EQ). (\*)

\* The measurement result is not utilized when [Analog Direct] is selected.

**Note**

- The D.C.A.C. is designed to achieve proper sound balance for your room. However, you can adjust the speaker levels manually according to your preference using [Test Tone].

## Related Topic

- [Outputting a test tone from each speaker \(Test Tone\)](#)

## Notes on use

4-488-933-11(1)

Copyright 2014 Sony Corporation





MULTI CHANNEL AV RECEIVER  
STR-DH750/STR-DH550

### Confirming active subwoofer setup

---

- When a subwoofer is connected, turn on the subwoofer and turn up the volume prior to activating the subwoofer. Turn the LEVEL to just before the mid-point.
- If you connect a subwoofer with a crossover frequency function, set the value to maximum.
- If you connect a subwoofer with an auto standby function, set it to off (deactivated).

**Note**

- Depending on the characteristics of the subwoofer you are using, the setup distance value may be different from the actual position.

#### Notes on use

4-488-933-11(1)

Copyright 2014 Sony Corporation



MULTI CHANNEL AV RECEIVER  
STR-DH750/STR-DH550

## Checking Auto Calibration results

---

To check error codes or warning messages received in [Auto Calibration], proceed with the following steps:

1. Select [WRN Check].

If a warning message appears, check the message and use the receiver without change. Or if necessary, perform Auto Calibration again.

For details on the warning messages, see “[List of messages after Auto Calibration measurements.](#)”

### When error code appears

Check the error and perform Auto Calibration again.

#### Hint

- The measurement results may vary depending on the position of the subwoofer. However, continuing to use the receiver with that value does not cause problems.

#### Related Topic

- [List of messages after Auto Calibration measurements](#)

### Notes on use

4-488-933-11(1)

Copyright 2014 Sony Corporation



MULTI CHANNEL AV RECEIVER  
STR-DH750/STR-DH550

## Menu list (on the display panel)

---

The following options are available in each menu.

### Auto Calibration settings [<AUTO CAL>]

- **Auto Calibration start [A.CAL START]**
- **Auto Calibration type [CAL TYPE] (\*1)**  
FULL FLAT, ENGINEER, FRONT REF, OFF

### Level settings [<LEVEL>]

- **Test Tone [TEST TONE] (\*2)** OFF, AUTO XXX (\*3)
- **Front left speaker level [FL LEVEL] (\*2)**  
FL -10.0 dB to FL +10.0 dB (0.5 dB interval)
- **Front right speaker level [FR LEVEL] (\*2)**  
FR -10.0 dB to FR +10.0 dB (0.5 dB interval)
- **Center speaker level [CNT LEVEL] (\*2)**  
CNT -10.0 dB to CNT +10.0 dB (0.5 dB interval)
- **Surround left speaker level [SL LEVEL] (\*2)**  
SL -10.0 dB to SL +10.0 dB (0.5 dB interval)
- **Surround right speaker level [SR LEVEL] (\*2)**  
SR -10.0 dB to SR +10.0 dB (0.5 dB interval)
- **Surround back speaker level [SB LEVEL] (for STR-DH750 only) (\*2)**  
SB -10.0 dB to SB +10.0 dB (0.5 dB interval)
- **Surround back left speaker level [SBL LEVEL] (for STR-DH750 only) (\*2)**  
SBL -10.0 dB to SBL +10.0 dB (0.5 dB interval)
- **Surround back right speaker level [SBR LEVEL] (for STR-DH750 only) (\*2)**  
SBR -10.0 dB to SBR +10.0 dB (0.5 dB interval)
- **Front left high speaker level [LH LEVEL] (for STR-DH750 only) (\*2)**  
LH -10.0 dB to LH +10.0 dB (0.5 dB interval)
- **Front right high speaker level [RH LEVEL] (for STR-DH750 only) (\*2)**  
RH -10.0 dB to RH +10.0 dB (0.5 dB interval)
- **Subwoofer Level [SW LEVEL] (\*2)**  
SW -10.0 dB to SW +10.0 dB (0.5 dB interval)

### Speaker settings [<SPEAKER>]

- **Speaker Pattern [SP PATTERN]**  
STR-DH750: 5/2.1 to 2/0 (20 patterns)  
STR-DH550: 3/2.1 to 2/0 (8 patterns)
- **Front speakers size [FRT SIZE] (\*2)**  
LARGE, SMALL
- **Center speaker size [CNT SIZE] (\*2)**

LARGE, SMALL

- **Surround speakers size [SUR SIZE] (\*2)**  
LARGE, SMALL
- **Front high speakers size [FH SIZE] (for STR-DH750 only) (\*2)**  
LARGE, SMALL
- **Surround back speaker assign [SB ASSIGN] (for STR-DH750 only) (\*4)**  
SPK B, BI-AMP, OFF
- **Front left speaker distance [FL DIST.] (\*2)**  
FL 1.00 m to FL 10.00 m (FL 3'3" to FL 32'9") (0.01 m (1 inch) interval)
- **Front right speaker distance [FR DIST.] (\*2)**  
FR 1.00 m to FR 10.00 m (FR 3'3" to FR 32'9") (0.01 m (1 inch) interval)
- **Center speaker distance [CNT DIST.] (\*2)**  
CNT 1.00 m to CNT 10.00 m (CNT 3'3" to CNT 32'9") (0.01 m (1 inch) interval)
- **Surround left speaker distance [SL DIST.] (\*2)**  
SL 1.00 m to SL 10.00 m (SL 3'3" to SL 32'9") (0.01 m (1 inch) interval)
- **Surround right speaker distance [SR DIST.] (\*2)**  
SR 1.00 m to SR 10.00 m (SR 3'3" to SR 32'9") (0.01 m (1 inch) interval)
- **Surround back speaker distance [SB DIST.] (for STR-DH750 only) (\*2)**  
SB 1.00 m to SB 10.00 m (SB 3'3" to SB 32'9") (0.01 m (1 inch) interval)
- **Surround back left speaker distance [SBL DIST.] (for STR-DH750 only) (\*2)**  
SBL 1.00 m to SBL 10.00 m (SBL 3'3" to SBL 32'9") (0.01 m (1 inch) interval)
- **Surround back right speaker distance [SBR DIST.] (for STR-DH750 only) (\*2)**  
SBR 1.00 m to SBR 10.00 m (SBR 3'3" to SBR 32'9") (0.01 m (1 inch) interval)
- **Front left high speaker distance [LH DIST.] (for STR-DH750 only) (\*2)**  
LH 1.00 m to LH 10.00 m (LH 3'3" to LH 32'9") (0.01 m (1 inch) interval)
- **Front right high speaker distance [RH DIST.] (for STR-DH750 only) (\*2)**  
RH 1.00 m to RH 10.00 m  
(RH 3'3" to RH 32'9") (0.01 m (1 inch) interval)
- **Subwoofer distance [SW DIST.] (\*2)**  
SW 1.00 m to SW 10.00 m  
(SW 3'3" to SW 32'9") (0.01 m (1 inch) interval)
- **Distance unit [DIST. UNIT]**  
FEET, METER
- **Front speakers crossover frequency [FRT CROSS] (\*5)**  
CROSS 40 Hz to CROSS 200 Hz (10 Hz interval)
- **Center speaker crossover frequency [CNT CROSS] (\*5)**  
CROSS 40 Hz to CROSS 200 Hz (10 Hz interval)
- **Surround speakers crossover frequency [SUR CROSS] (\*5)**  
CROSS 40 Hz to CROSS 200 Hz (10 Hz interval)
- **Front high speakers crossover frequency [FH CROSS] (for STR-DH750 only) (\*5)**  
CROSS 40 Hz to CROSS 200 Hz (10 Hz interval)

## Input settings [<INPUT>]

- **Input Mode [INPUT MODE]**  
AUTO, OPT, COAX, ANALOG
- **Naming inputs [NAME IN]**  
For details, see "[Changing the name for each input \(Name In\).](#)" in Input Settings menu.
- **Digital audio input assignment [A. ASSIGN]**  
OPT 1, OPT 2, COAX, NONE

## Surround settings [<SURROUND>]

- **HD-D.C.S. effect type [HD-D.C.S. TYP]** (\*6)  
DYNAMIC, THEATER, STUDIO

## EQ settings [<EQ>]

- **Front speakers bass level [BASS]**  
BASS -10 dB to BASS +10 dB (1 dB interval)
- **Front speakers treble level [TREBLE]**  
TREBLE -10 dB to TREBLE +10 dB (1 dB interval)

## Tuner settings [<TUNER>]

- **FM station receiving mode [FM MODE]**  
STEREO, MONO
- **Naming preset stations [NAME IN]**  
For details, see [“Naming preset stations \(Name Input\).”](#)

## Audio settings [<AUDIO>]

- **Night Mode [NIGHT MODE]**  
NIGHT ON, NIGHT OFF
- **Synchronizes audio with video output [A/V SYNC]**  
SYNC ON, SYNC OFF
- **Auto Volume [AUTO VOL]**  
A. VOL ON, A. VOL OFF
- **Digital broadcast language selection [DUAL MONO]**  
MAIN/SUB, MAIN, SUB
- **Dynamic range compressor [D. RANGE]**  
COMP. ON, COMP. AUTO, COMP. OFF

## HDMI settings [<HDMI>]

- **Control for HDMI [CTRL: HDMI]**  
CTRL ON, CTRL OFF
- **Pass Through [PASS THRU]**  
ON (\*7), AUTO, OFF
- **HDMI Audio Out [AUDIO OUT]**  
AMP, TV+AMP
- **HDMI Subwoofer Level [SW LEVEL]**  
SW AUTO, SW +10 dB, SW 0 dB
- **Fast View [FAST VIEW]**  
AUTO, OFF
- **MHL Auto Input [MHL.AUTO IN]**  
ON, OFF

## BLUETOOTH settings [<BT>] (for STR-DH750 only)

- **BLUETOOTH Standby mode [BT STANDBY]** (\*8)  
STBY ON, STBY OFF
- **BLUETOOTH AAC [BT AAC]**  
AAC ON, AAC OFF
- **BLUETOOTH aptX [BT APTX]**

APTX ON, APTX OFF

- **BLUETOOTH Power [BT POWER]**

BT ON, BT OFF

### **System settings [<SYSTEM>]**

- **Auto standby mode [AUTO STBY]**

STBY ON, STBY OFF

- **Version display [VER. X.XXX] (\*9)**

\*1 You can select this setting only when you have performed Auto Calibration and saved the settings.

\*2 Some parameters or settings may not be available depending on the speaker pattern setting.

\*3 XXX represents a speaker channel (FL, FR, CNT, SL, SR, SB, SBL, SBR, LH, RH, SW).

\*4 You can only select this parameter if [SP PATTERN] is not set to a pattern with surround back and front high speakers.

\*5 You can only select this parameter if the speaker is set to [SMALL].

\*6 You can only select this parameter if you select [HD-D.C.S.] as the sound field.

\*7 For USA, Canadian, and Australian models only

\*8 You can only select this parameter when a BLUETOOTH device is paired.

\*9 X.XXX represents the version number.

### [Notes on use](#)

4-488-933-11(1)

Copyright 2014 Sony Corporation